

SIDE VIEW

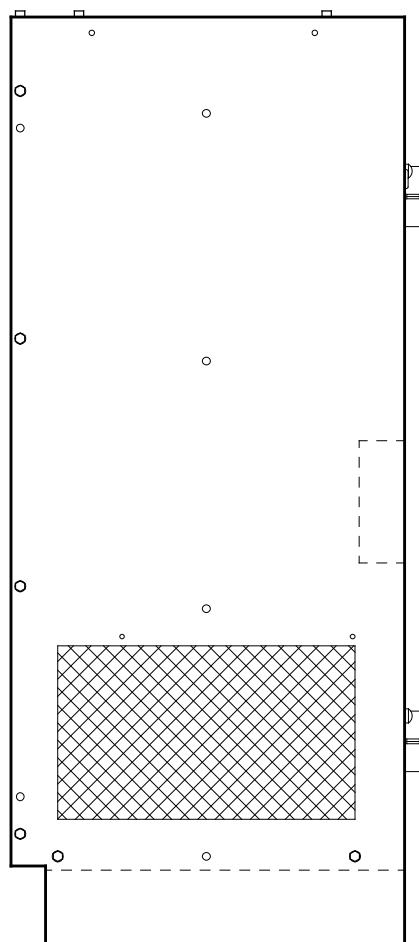

FRONT VIEW

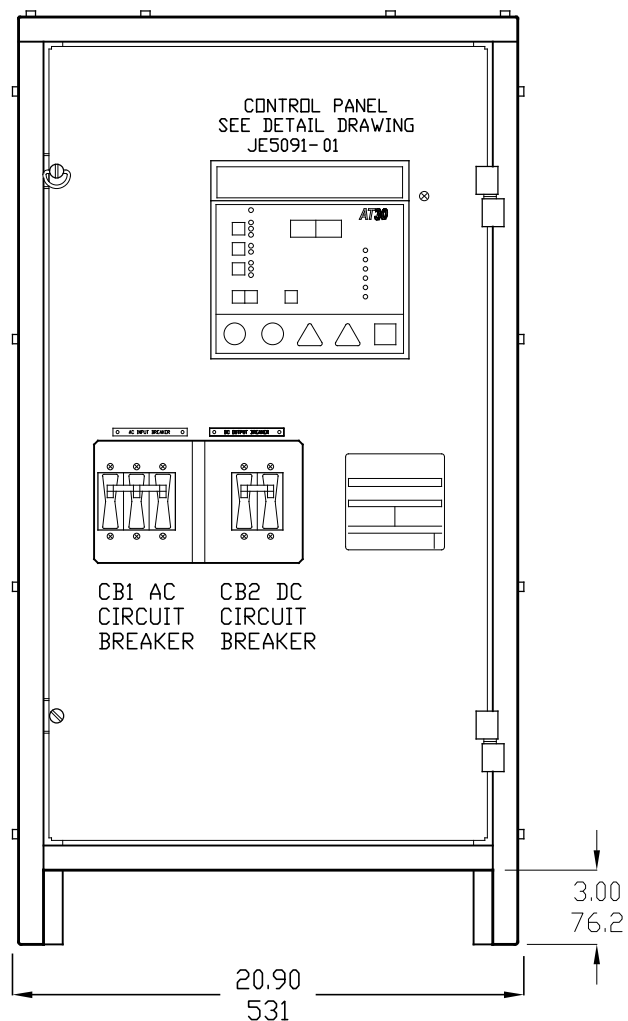

SIDE VIEW

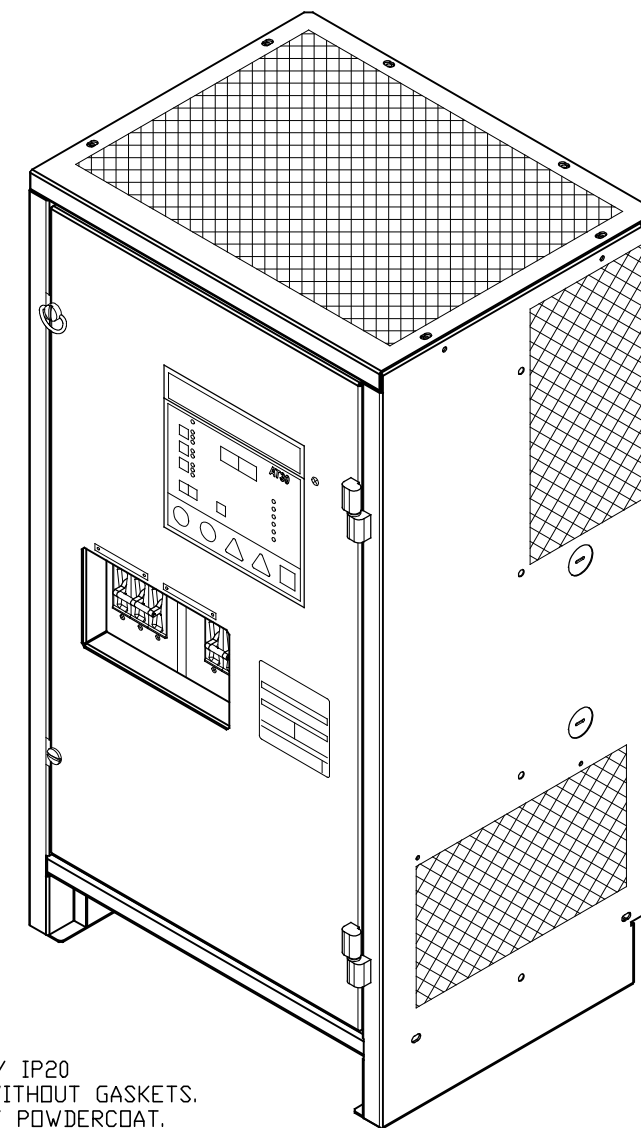
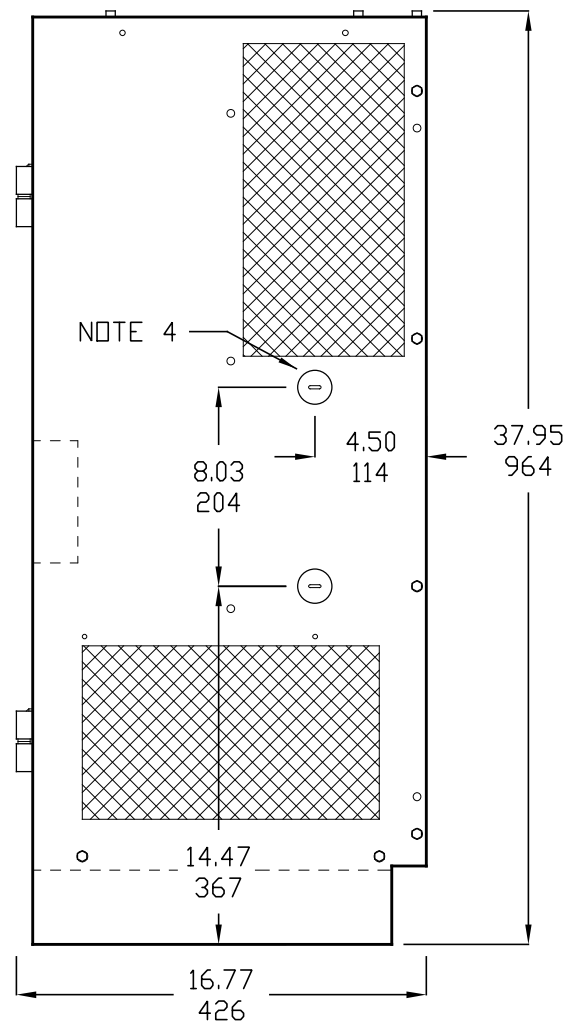

NOTES:

- 1) ENCLOSURE IS A NEMA TYPE 1 / IP20 TOP-VENTED STEEL CABINET WITHOUT GASKETS. FINISH IS ANSI-61 GRAY EPOXY POWDERCOAT.
- 2) ALLOW 6in / 152mm OF FREE AIR ON ALL VENTED SURFACES (TOP, SIDES & REAR) FOR COOLING.
- 3) FOUR (4) 1in x 0.625in / 25mm x 16mm FLOOR-MOUNTING SLOTS ARE PROVIDED ON BOTTOM OF ENCLOSURE AS SHOWN.
- 4) TWO (2) 1.31in / 33mm DIA STANDARD PRE-FAB KEY-SLOT KNOCKOUTS ARE PROVIDED AS SHOWN FOR 1in / 25mm CONDUIT ENTRY. IF ADDITIONAL CONDUIT ENTRANCES ARE REQUIRED, ENCLOSURE SHOULD BE FIELD-MODIFIED BY INSTALLER.
- 5) BATTERY CHARGER SHIPPING WEIGHT: SEE PRODUCT LITERATURE.

BOTTOM VIEW

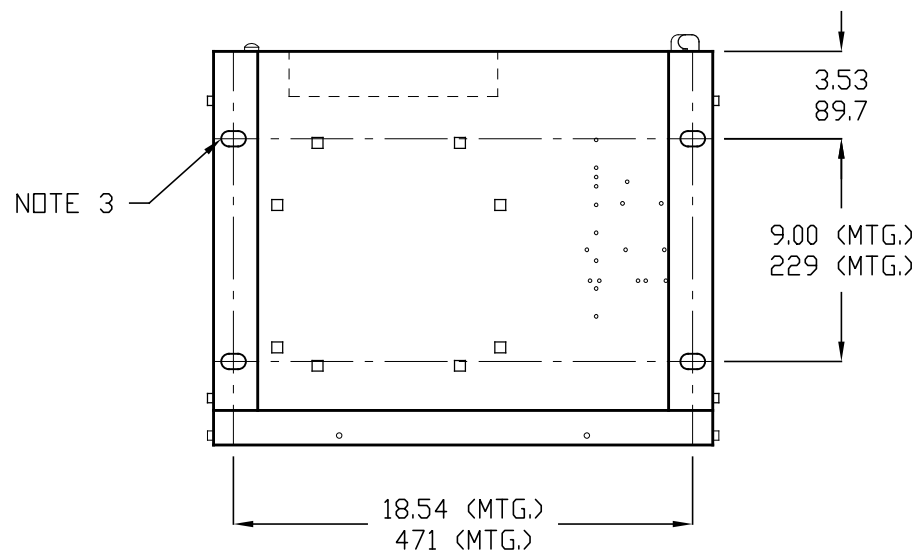

DUAL DIMENSIONS in mm

25-100ADC W/O OPTIONS

			<p>THIRD ANGLE PROJECTION</p>		<p>1075 Saint John Street Easton, PA 18042-6661 PH 610-330-9000 FAX 610-330-8510 www.hindlepowerinc.com</p>	
			<p>DRAWN BY KMW 110421</p> <p>ELECTRONIC APPROVAL SIGNATURES MAINTAINED BY MFG ECN LOG</p>	<p>TITLE AT30 SERIES BATTERY CHARGER OUTLINE: NEMA-1 STYLE-5018 ENCLOSURE</p>		
0	N/A	110421	<p>UNLESS OTHERWISE NOTED DIMENSIONS ARE IN INCHES. TOLERANCES ARE:</p>		<p>DRAWING No JE5085-01 REV 0 B</p>	
REV	ECN No	DATE	SCALE NTS	SALES No	SHEET 1 OF 1	

SYM	STANDARD COMPONENT DESCRIPTION
A1	MAIN CONTROL PC BOARD
A15	THREE PHASE GATE DRIVER PC BRD
A16	3PH SCR MODULE (3x2 Q1-Q6)
A17x	SCR SNUBBER PC BOARD - QTY. (3)
C4	EMI OUTPUT FILTER CAP (NEG-GND)
C5	EMI OUTPUT FILTER CAP (POS-GND)
CB1	AC INPUT CIRCUIT BREAKER (CD3)
CB2	DC OUTPUT CIRCUIT BREAKER (CD2)
CR4	FREE-WHEELING DIODE
L1	MAIN INDUCTOR
R1	MAIN DC SHUNT, NEG(-) BUS
R2	CURRENT RATING RESISTOR
R3	PWR SUPPLY BALLAST RES (130VDC)
T1	POWER ISOLATION TRANSFORMER
TB1	I/O TERMINAL BOARD
TB3	SUMMARY ALARM CONTACTS
TB8	TEMPCD PROBE TERMINAL BLOCK
VR1	OUTPUT SURGE SUPPRESSOR (+TO-)
VR2	INPUT SURGE SUPPRESSOR (LINE 1)
VR4	INPUT SURGE SUPPRESSOR (LINE 2)
VR5	INPUT SURGE SUPPRESSOR (LINE 3)
VR6	OUTPUT SURGE SUPPRESSOR (-)
VR7	OUTPUT SURGE SUPPRESSOR (+)

SYM	FEATURED OPTION COMP DESCRIPTION
C1x	DC OUTPUT FILTER CAPACITOR
CR1	POLARITY DIODE
E13	INDUCTOR INTER-CONNECT POINT
L2	FILTER INDUCTOR
R9	FILTER CAP (C1) BLEED RESISTOR

SIDE SECTION

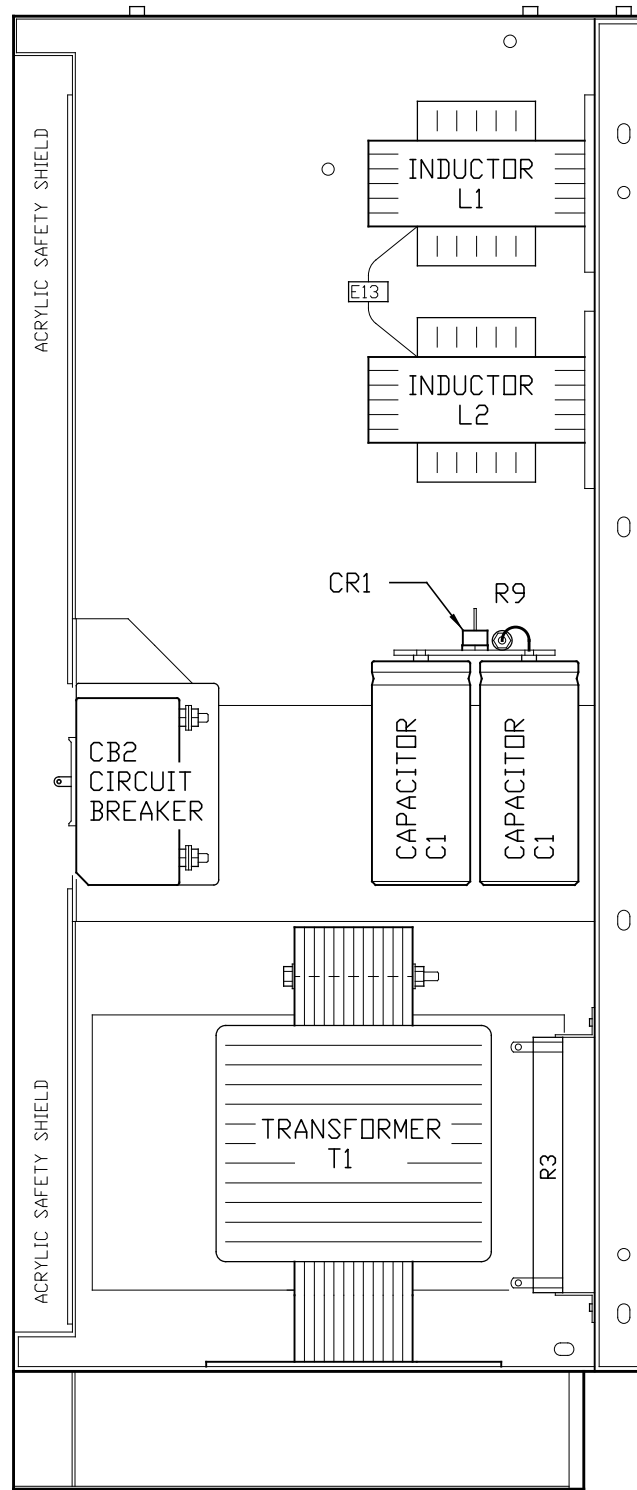

FRONT VIEW

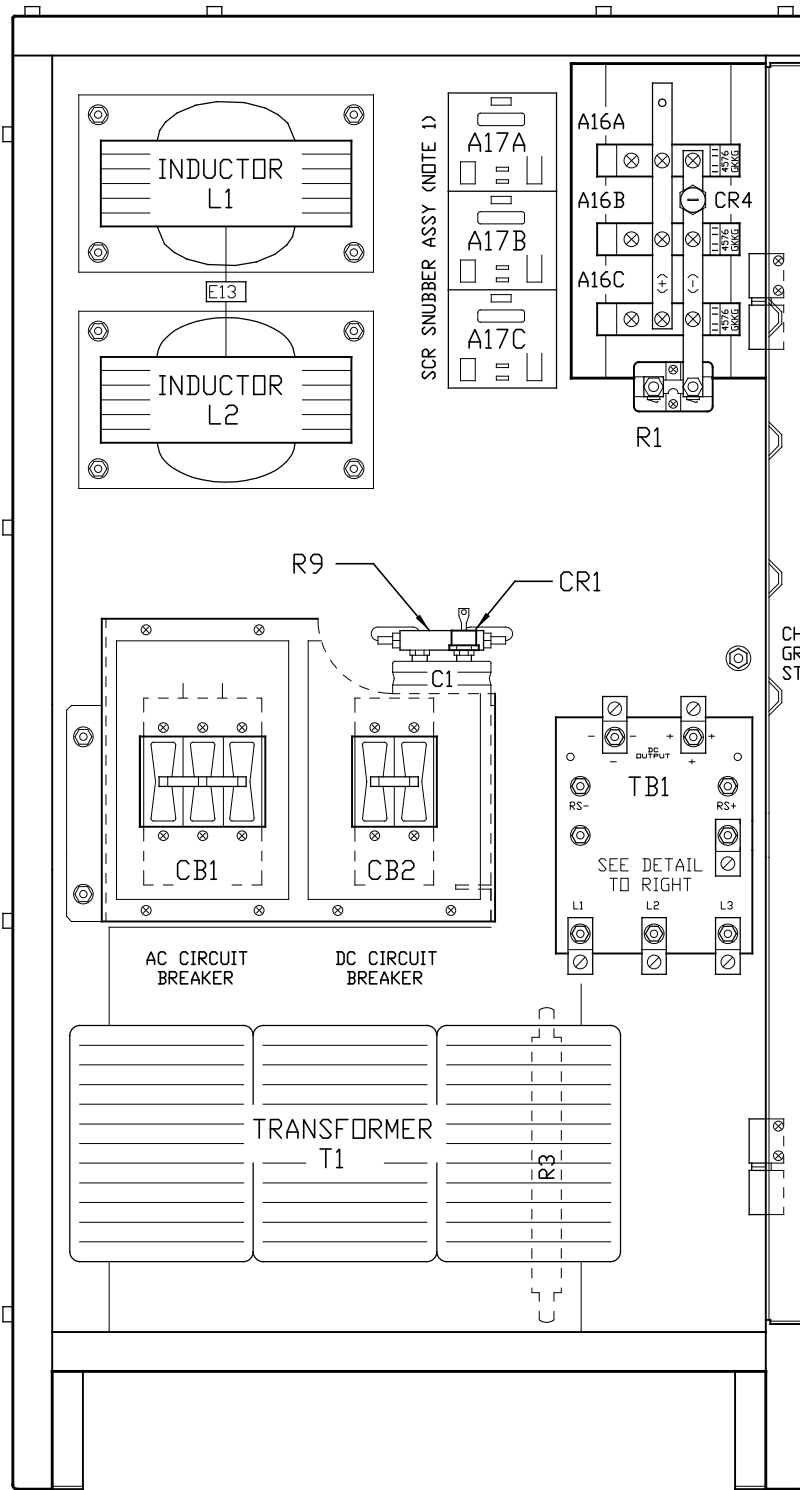

BACK SIDE OF FRONT DOOR

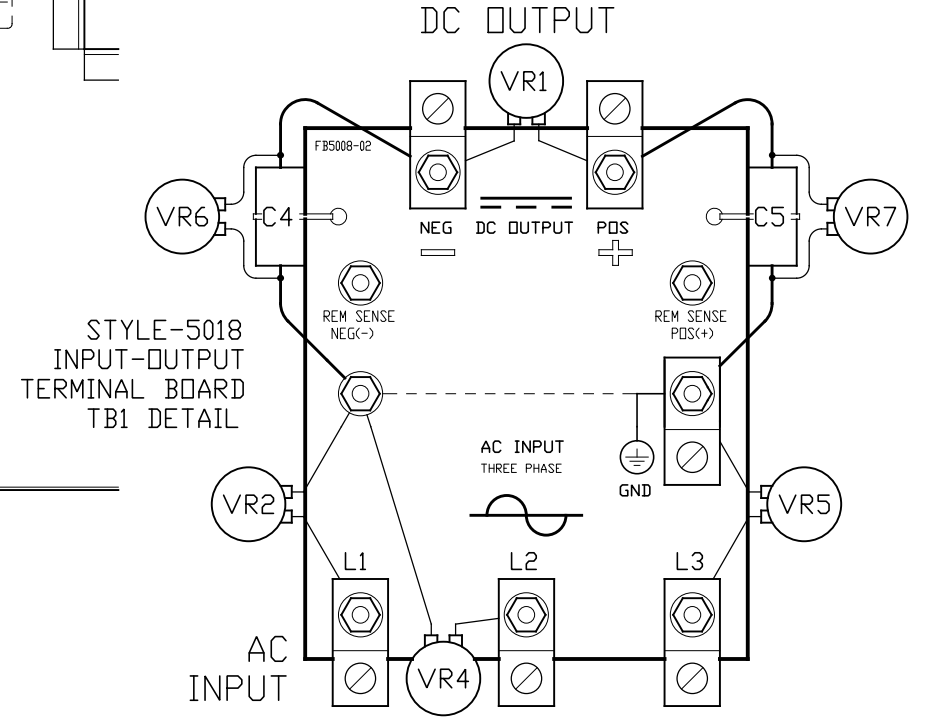
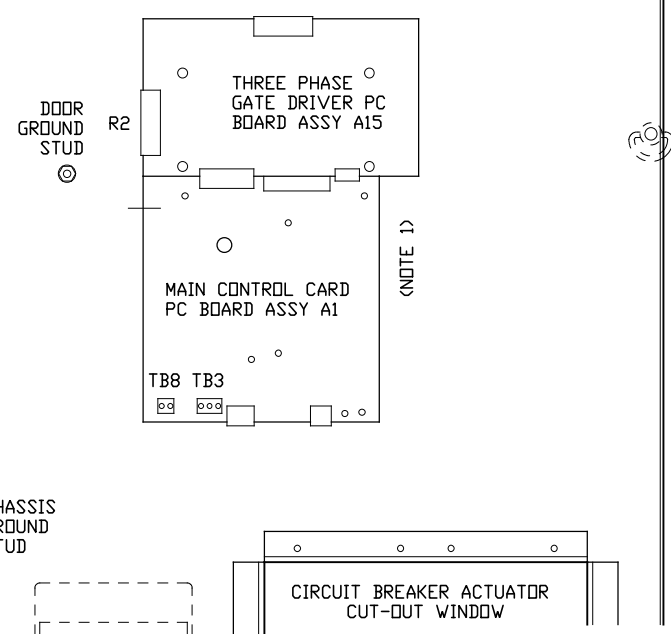

25-100ADC W/O OPTIONS

I/O TERMINAL	DESCRIPTION - TYPE	CONNECTION
TB1(+/-)	POS/NEG DC OUTPUT TERMS - CU-ALUMINUM COMPRESSION LUG	#14-1/0 AWG
REM SENSE(+/-)	POS/NEG REMOTE SENSE TERMINALS - 1/4-20 ZPS STUDS	1/4in RING LUG
TB1-GND	USER GROUND TERMINAL - CU-ALUMINUM COMPRESSION LUG	#14-1/0 AWG
TB1-L1/L2/L3	AC INPUT TERMINALS - CU-ALUMINUM COMPRESSION LUG	#14-1/0 AWG
TB3	SUMMARY ALARM TERMINAL BLOCK - SOLDERLESS COMP SCREW	#22-14 AWG
TB8	TEMPCD PROBE (A10) TERM BLK - SOLDERLESS COMP SCREW	#22-14 AWG

NOTES:
 1) FOR DETAIL VIEWS OF ALL PC BOARDS (A1, A5, A15, A17, etc.) SEE DETAIL JE5091-01.

			 THIRD ANGLE PROJECTION		 1075 Saint John Street Easton, PA 18042-6661 PH 610-330-9000 FAX 610-330-8510 www.hindlepowerinc.com		
			DRAWN BY KMW	110421			TITLE AT30 SERIES BATTERY CHARGER INTERNAL COMPONENT LAYOUT: STYLE-5018
0	N/A	110421	ELECTRONIC APPROVAL SIGNATURES MAINTAINED BY MFG ECN LOG UNLESS OTHERWISE NOTED DIMENSIONS ARE IN INCHES. TOLERANCES ARE:		DRAWING No JE5088-01	REV 0	B
REV	ECN No	DATE			SCALE NTS	SALES No	SHEET 1

- INDICATOR LIGHTS (LEDs):
- DS01 - GREEN - AC ON
 - DS02 - RED - DC VOLTS
 - DS03 - RED - DC AMPERES
 - DS04 - RED - EQUALIZE HRS REMAINING
 - DS05 - GREEN - FLOAT
 - DS06 - AMBER - EQUALIZE
 - DS07 - AMBER - MANUAL TIMER
 - DS08 - AMBER - MANUAL EQUALIZE
 - DS09 - AMBER - AUTO EQUALIZE TIMER

- DS10 - RED - LOW LEVEL DETECT
- DS11 - RED - (METER DISPLAY)
- DS12 - RED - (METER DISPLAY)
- DS13 - RED - HIGH DC VOLTAGE
- DS14 - RED - LOW DC VOLTAGE
- DS15 - RED - DC OUTPUT FAILURE
- DS16 - RED - AC INPUT FAILURE
- DS17 - RED - POS(+) GROUND FAULT
- DS18 - RED - NEG(-) GROUND FAULT

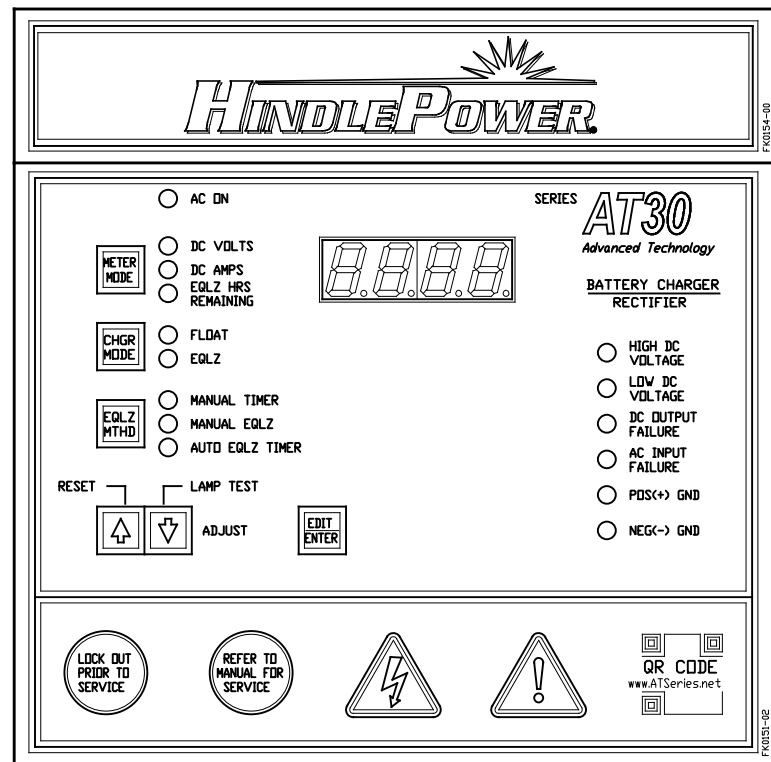

CONTROL PANEL
(PART No. FK0151-02)

NOTE: UNLESS OTHERWISE SPECIFIED, ALL USER TERMINAL BLOCKS (TB3/TB4/TB8) ARE SOLDERLESS COMPRESSION TERMINALS, ACCEPTING #22-14 AWG WIRE. ALL ALARM CONTACTS SHOWN IN NON-ALARM STATE, WITH CHARGER ENERGIZED AND ALARM RELAYS ENERGIZED (FAIL SAFE). ALL ALARM CONTACTS WILL CHANGE STATE WHEN CHARGER IS POWERED DOWN. CONTACT RATING IS 0.5A @ 125VAC/VDC RESISTIVE.

THREE PHASE GATE DRIVER PC BOARD (A15)

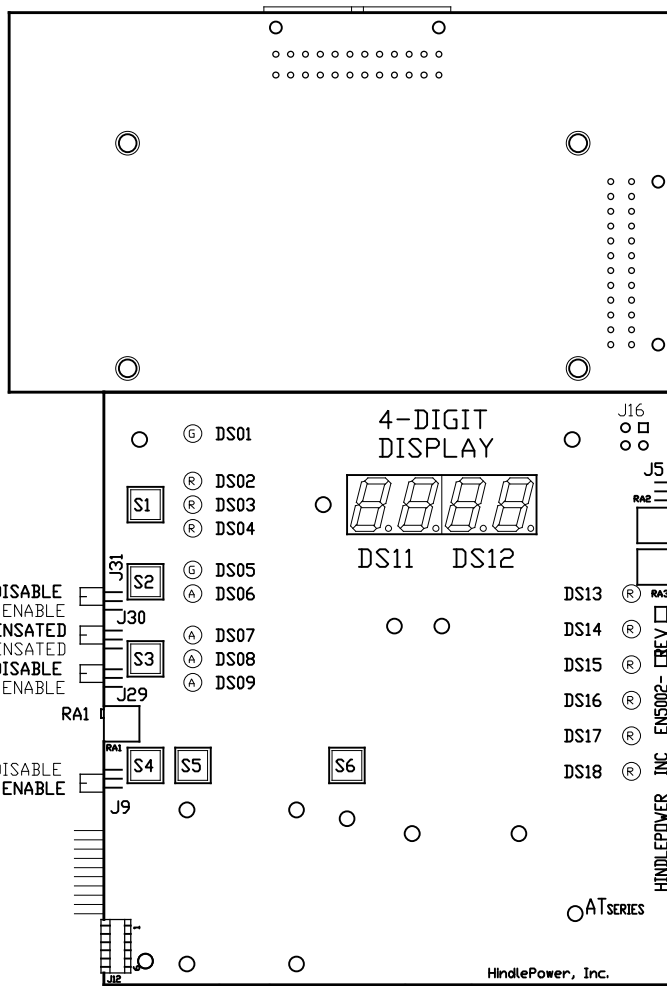

MAIN CONTROL PC BOARD (A1)

FRONT VIEW - FACING CHARGER DOOR WHEN INSTALLED

THREE PHASE GATE DRIVER PC BOARD (A15)

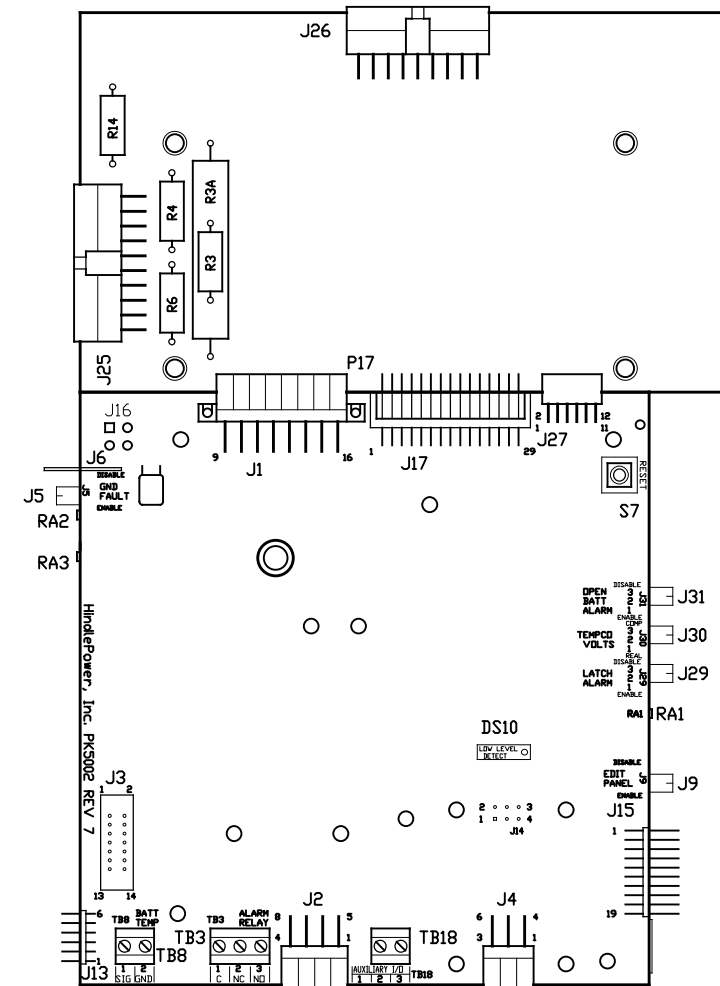

MAIN CONTROL PC BOARD (A1)

BACK VIEW - FACING CHARGER COMPONENTS WHEN INSTALLED

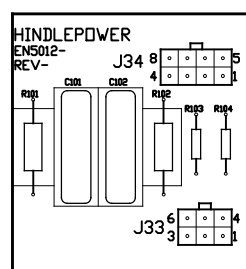

SCR SNUBBER
PC BOARD (A17x)
THREE (3) REQ'D
PER CHARGER

USER JUMPERS:

- J1 - not used with 3PH (MAINFRAME SIGNAL HARNESS)
- J2 - AUX ALARM RELAY BOARD (A5) SERIAL CONNECTOR
- J4 - FORCED LOAD SHARING CABLE INTERCONNECTOR
- J5 - GROUND FAULT ENABLE/DISABLE
- J6 - EARTH GROUND CONNECTOR
- J9 - FRONT PANEL ENABLE/DISABLE (LOCKOUT)
- J13 - COMMUNICATIONS PC BOARD (A12) INTERCONNECTOR
- J17 - 3PH GATE DRIVER PC BOARD (A15) INTERCONNECTOR
- J25 - MAINFRAME CONTROL SIGNAL HARNESS
- J26 - SCR FIRING CONTROL HARNESS (3 PHASE/6 PULSE)
- J27 - 3PH GATE DRIVER PC BOARD (A15) INTERCONNECTOR
- J29 - LATCHING ALARMS ENABLE/DISABLE SELECTOR
- J30 - TEMP CD VOLTAGES (COMPENSATED/UNCOMP) SELECTOR
- J31 - BATTERY OPEN ALARM ENABLE/DISABLE SELECTOR

SWITCHES:

- S1 - METER MODE
 - S2 - CHARGER MODE
 - S3 - EQUALIZE METHOD
 - S4 - ΔADJUST
 - S5 - ▽ADJUST
 - S6 - EDIT / ENTER
 - S7 - PROCESSOR MANUAL RESET
- TERMINAL BLOCKS:
- TB3 - SUMMARY ALARM RELAY CONTACTS
 - TB8 - OPT TEMP CD PROBE (A10) CONN
 - TB18 - REM SHUTDOWN INTERFACE

- OTHER CONTROLS:
- RA1 - LOW LEVEL DETECT ADJUST
 - RA2 - GROUND FAULT BALANCE
 - RA3 - GROUND FAULT SENSITIVITY

- NON-USER ACCESSED JUMPERS:
- J3 - DLD A5 RIBBON CONNECTOR
 - J12 - BOARD PROGRAMMING
 - J14 - DLD FORCED LOAD SHARING
 - J15 - MANUFACTURING TEST
 - J16 - DLD INTERNAL TEMP

25-100ADC W/O OPTIONS

			THIRD ANGLE PROJECTION				1075 Saint John Street Easton, PA 18042-6661 PH 610-330-9000 FAX 610-330-8510 www.hindlepowerinc.com	
			DRAWN BY KMW 110421		TITLE AT30 SERIES BATTERY CHARGER CONTROL PANEL / PC BOARD DETAIL			
			ELECTRONIC APPROVAL SIGNATURES MAINTAINED BY MFG ECN LOG		DRAWING No JE5091-01		REV 0A B	
			UNLESS OTHERWISE NOTED DIMENSIONS ARE IN INCHES. TOLERANCES ARE:		SCALE NTS		SALES No	
0	N/A	110421			SHEET 1 OF 1			
REV	ECN No	DATE						

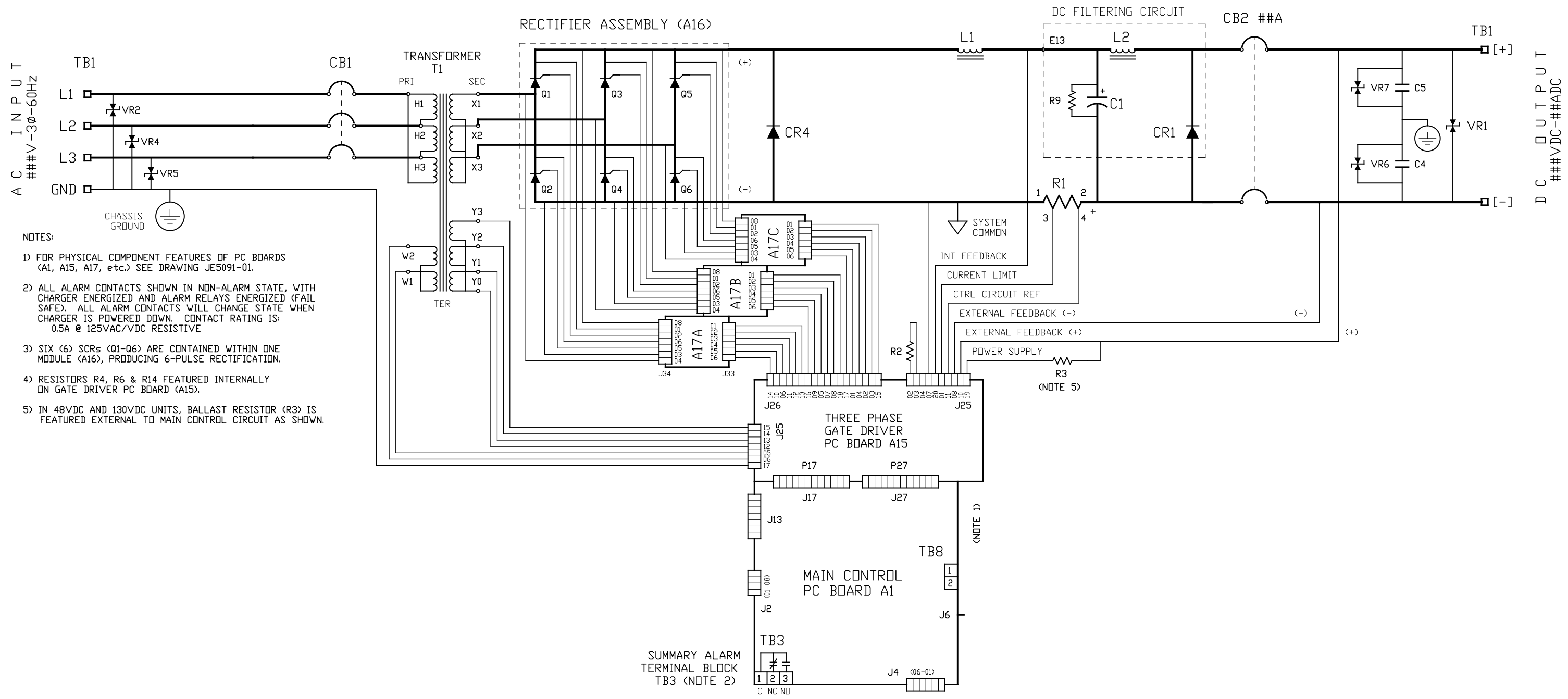

- NOTES:
- FOR PHYSICAL COMPONENT FEATURES OF PC BOARDS (A1, A15, A17, etc.) SEE DRAWING JE5091-01.
 - ALL ALARM CONTACTS SHOWN IN NON-ALARM STATE, WITH CHARGER ENERGIZED AND ALARM RELAYS ENERGIZED (FAIL SAFE). ALL ALARM CONTACTS WILL CHANGE STATE WHEN CHARGER IS POWERED DOWN. CONTACT RATING IS: 0.5A @ 125VAC/VDC RESISTIVE
 - SIX (6) SCRS (Q1-Q6) ARE CONTAINED WITHIN ONE MODULE (A16), PRODUCING 6-PULSE RECTIFICATION.
 - RESISTORS R4, R6 & R14 FEATURED INTERNALLY ON GATE DRIVER PC BOARD (A15).
 - IN 48VDC AND 130VDC UNITS, BALLAST RESISTOR (R3) IS FEATURED EXTERNAL TO MAIN CONTROL CIRCUIT AS SHOWN.

STANDARD AT30 COMPONENTS:

- A1 MAIN CONTROL PC BOARD (NOTE 1)
- A15 THREE PHASE GATE DRIVER PC BOARD (NOTE 1)
- A16 6-PULSE SCR (Q1-Q6) MODULE (NOTE 3)
- A17A SCR SNUBBER ASSY PC BOARD (NOTE 1)
- A17B SCR SNUBBER ASSY PC BOARD (NOTE 1)
- A17C SCR SNUBBER ASSY PC BOARD (NOTE 1)
- C4 DC OUTPUT EMI FILTER CAPACITOR (-) TO GROUND
- C5 DC OUTPUT EMI FILTER CAPACITOR (+) TO GROUND
- CB1 AC INPUT CIRCUIT BREAKER
- CB2 DC OUTPUT CIRCUIT BREAKER
- CR4 FREE-WHEELING DIODE
- L1 MAIN INDUCTOR
- Q1 SILICON-CONTROLLED RECTIFIER (A16A) (NOTE 3)
- Q2 SILICON-CONTROLLED RECTIFIER (A16A) (NOTE 3)
- Q3 SILICON-CONTROLLED RECTIFIER (A16B) (NOTE 3)
- Q4 SILICON-CONTROLLED RECTIFIER (A16B) (NOTE 3)
- Q5 SILICON-CONTROLLED RECTIFIER (A16C) (NOTE 3)
- Q6 SILICON-CONTROLLED RECTIFIER (A16C) (NOTE 3)

STANDARD AT30 COMPONENTS:

- R1 MAIN DC SHUNT, NEG(-) BUS (NOTE 1)
- R2 CURRENT RATING RESISTOR (NOTE 1)
- R3 POWER SUPPLY BALLAST RESISTOR (NOTE 5)
- R4 EXTERNAL SCALING RESISTOR (+) (NOTE 4)
- R6 INTERNAL SCALING RESISTOR (NOTE 4)
- R14 EXTERNAL SCALING RESISTOR (-) (NOTE 4)
- T1 POWER ISOLATION TRANSFORMER (+10/-12%)
- TB1 INPUT/OUTPUT TERMINAL BLOCK
- TB3 SUMMARY ALARM TERMINAL BLOCK (NOTE 2)
- TB8 OPTIONAL TEMP/CO PROBE (A10) INTERCONNECTOR
- VR1 DC OUTPUT SURGE SUPPRESSOR (-) TO (+)
- VR2 AC INPUT SURGE SUPPRESSOR (LINE 1)
- VR4 AC INPUT SURGE SUPPRESSOR (LINE 2)
- VR5 AC INPUT SURGE SUPPRESSOR (LINE 3)
- VR6 DC OUTPUT SURGE SUPPRESSOR (-) TO GROUND
- VR7 DC OUTPUT SURGE SUPPRESSOR (+) TO GROUND

FEATURED AT30 OPTION COMPONENTS:

- DC FILTERING ASSEMBLY:
- C1 DC OUTPUT FILTERING CAPACITOR
 - CR1 POLARITY DIODE
 - E13 INDUCTOR INTERCONNECTION POINT
 - L2 FILTERING INDUCTOR
 - R9 FILTER CIRCUIT BLEED RESISTOR

			 THIRD ANGLE PROJECTION		 1075 Saint John Street Easton, PA 18042-6661 PH 610-330-9000 FAX 610-330-8510 www.hindlepowerinc.com	
			DRAWN BY KMW	110421	TITLE BATTERY CHARGER SCHEMATIC: 25-100ADC W/O OPTIONS	
			ELECTRONIC APPROVAL SIGNATURES MAINTAINED BY MFG ECN LOG		DRAWING No JE5092-01	
			UNLESS OTHERWISE NOTED DIMENSIONS ARE IN INCHES. TOLERANCES ARE:		REV 0	B
0	N/A	110421			SCALE NTS	SHEET 1 OF 1
REV	ECN No	DATE			SALES No	

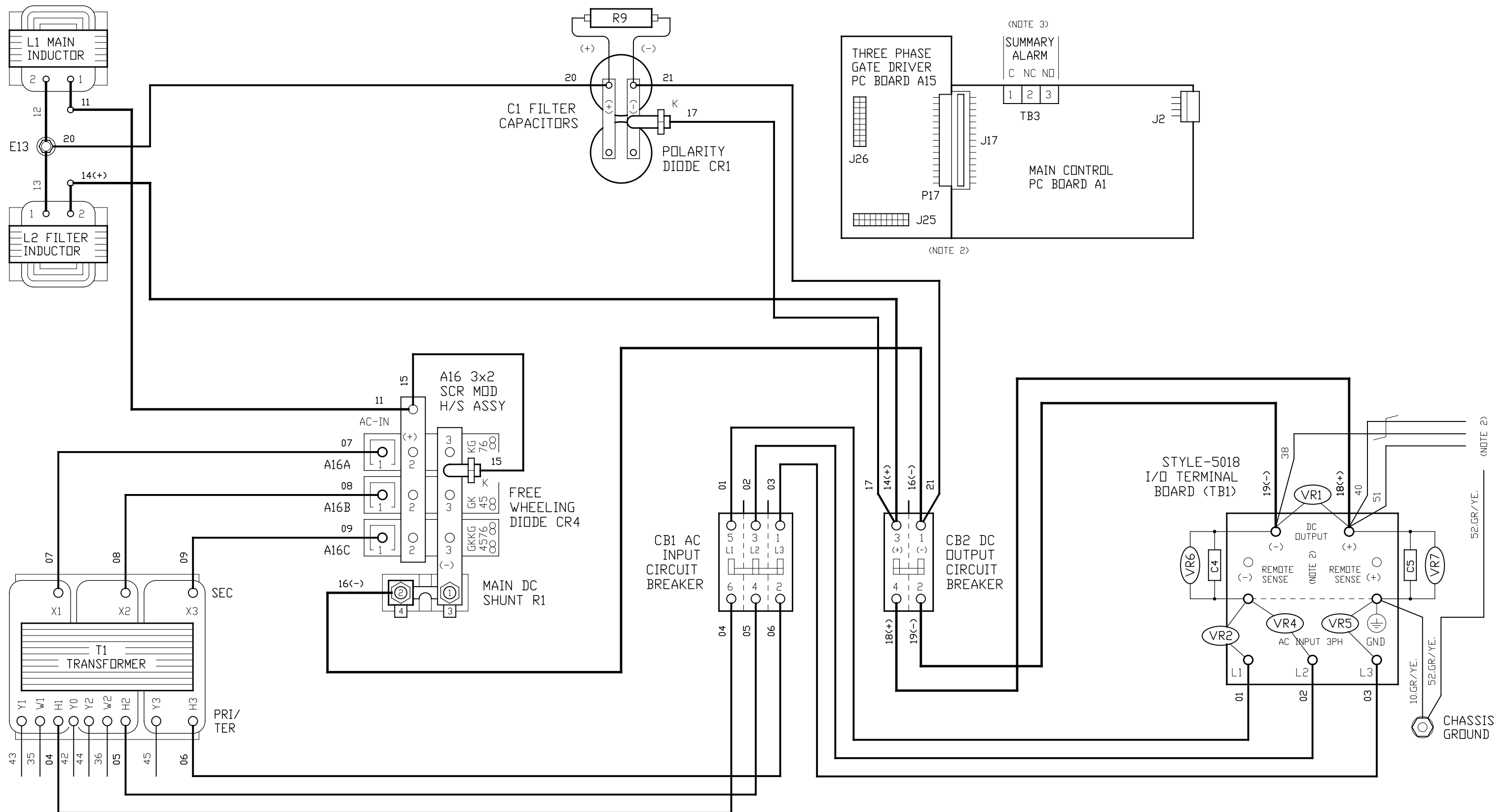

NOTES:

- 1) CHARGER COMPONENTS ARE CONNECTED WITH BLACK FLAME-RETARDANT SWITCHBOARD INSULATION SYSTEM (SIS) TYPE WIRING, IDENTIFIED ON EACH END WITH NUMBER-CODED WIRE MARKERS. GROUND WIRES ARE GREEN WITH YELLOW STRIPE. DIODES (CR1 & CR4) ARE ANODE-MOUNTED TYPE, WIRE TO CATHODE.
- 2) THIS DRAWING (SHEET 1) DEPICTS THE AT30 MAINFRAME POWER WIRING AND USER CONNECTION CONTACTS TO CONTROL PC BOARDS (A1 & A5). SEE SHEET 2 FOR ALL CONTROL (SIGNAL) WIRING, INCLUDING REMOTE SENSE MODIFICATIONS, IF APPLICABLE.
- 3) STANDARD USER ALARM CONTACTS (TB3, TB4, etc.) ARE SOLDERLESS COMPRESSION SCREW TERMINALS, ACCEPTING #22-14 AWG WIRE.

FEATURED OPTIONS:

- STANDARD DC OUTPUT FILTERING
- AC INPUT CIRCUIT BREAKER
- DC OUTPUT CIRCUIT BREAKER

			THIRD ANGLE PROJECTION		1075 Saint John Street Easton, PA 18042-6661 PH 610-330-9000 FAX 610-330-8510 www.hindlepowerinc.com	
			DRAWN BY KMW	110421	TITLE BATTERY CHARGER CONNECTION DIAGRAM: 25-100ADC W/O OPTIONS	
			ELECTRONIC APPROVAL SIGNATURES MAINTAINED BY MFG ECN LOG		DRAWING No JE5093-01	
			UNLESS OTHERWISE NOTED DIMENSIONS ARE IN INCHES. TOLERANCES ARE:		REV 0	B
0	N/A	110421			SCALE NTS	SHEET 1 OF 2
REV	ECN No	DATE			SALES No	FILENAME [JH0015-01.DWG]

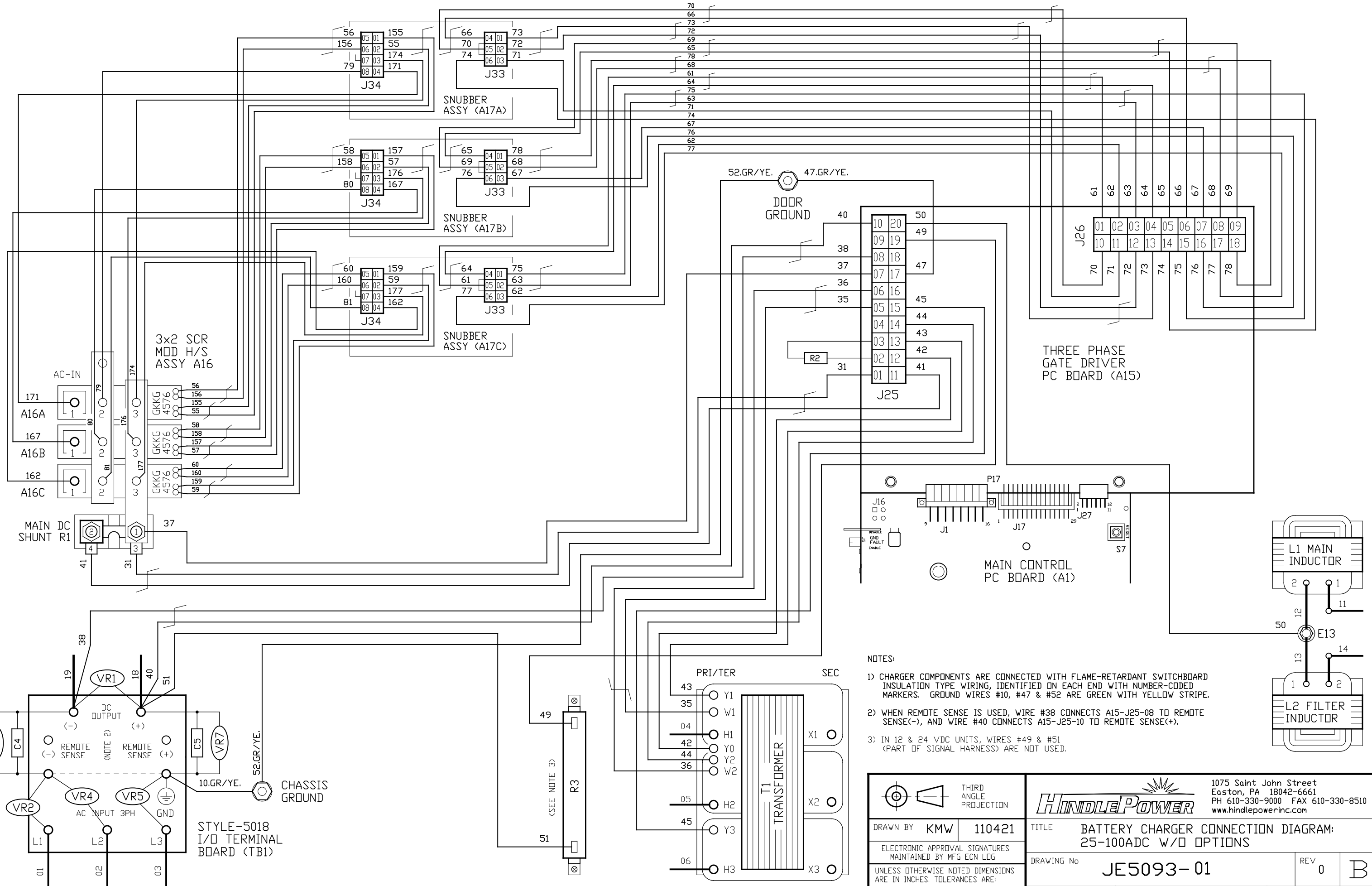

- NOTES:
- 1) CHARGER COMPONENTS ARE CONNECTED WITH FLAME-RETARDANT SWITCHBOARD INSULATION TYPE WIRING, IDENTIFIED ON EACH END WITH NUMBER-CODED MARKERS. GROUND WIRES #10, #47 & #52 ARE GREEN WITH YELLOW STRIPE.
 - 2) WHEN REMOTE SENSE IS USED, WIRE #38 CONNECTS A15-J25-08 TO REMOTE SENSE(-), AND WIRE #40 CONNECTS A15-J25-10 TO REMOTE SENSE(+).
 - 3) IN 12 & 24 VDC UNITS, WIRES #49 & #51 (PART OF SIGNAL HARNESS) ARE NOT USED.

THIRD ANGLE PROJECTION		1075 Saint John Street Easton, PA 18042-6661 PH 610-330-9000 FAX 610-330-8510 www.hindlepowerinc.com	
DRAWN BY KMW	110421	TITLE BATTERY CHARGER CONNECTION DIAGRAM: 25-100ADC W/D OPTIONS	
ELECTRONIC APPROVAL SIGNATURES MAINTAINED BY MFG ECN LG		DRAWING No JE5093-01	REV 0
UNLESS OTHERWISE NOTED DIMENSIONS ARE IN INCHES. TOLERANCES ARE:		SCALE NTS	SALES No
		SHEET 2 OF 2	B