



HINDLEPOWER

ATEVO SERIES BATTERY CHARGER



ATEVO



HINDLE HEAL+H SYSTEM
PRODUCT

OPERATING INSTRUCTIONS

HindleHealth+ (smart battery shunt)

JA5011-55

USER NOTES

HindleHealth+ Battery Sensor for ATevo Series Charger

CONTENTS	page	
1 Introduction	1	8 Alarms..... 12
2 What Does HindleHealth+ Do?	1	9 Battery Event Logging
3 System Requirements.....	1	10 Parallel Charger Operation
4 Battery Commission Worksheet.....	2	11 Modbus Master
5 Installation.....	3	12 Parts Data Package (spare parts)
6 Commissioning	5	13 Specifications.....
7 Features.....	9	14 Related Documentation
		Document Control Information.....

1 INTRODUCTION

HindleHealth+ (ordering p/n EJ5178-00) is a self-contained ATevo charger accessory for monitoring overall battery health, and reporting complete dc system availability. Housed within a small wall-mounted enclosure, HH+ consists of a smart dc shunt, control pc board, and user I/O terminals. Wiring accessories included with HH+ are a remote battery temperature probe, +Vdc sense wiring, communications wiring, and a battery charger interface pc board for ATevo. HindleHealth+ provides compliance, with portion dealing with proof of battery availability, of the North American Electric Reliability Corporation (NERC) standard **TPL-0001**. The following technical document details implementation of Modbus master and support for HindleHealth+ Sensor in ATevo firmware.

2 WHAT DOES HindleHealth+ DO?

When installed, connected to a stationary industrial-grade battery, and properly connected to an ATevo charger, HindleHealth+ will provide users access to the following information:

- continuous open battery monitoring (for alarm)
- calculated battery Ah capacity remaining
- battery charge/discharge metering (+/- Adc)
- battery discharge monitoring (for alarm)
- battery temperature via wired remote probe w/ring lug
 - battery temperature voltage compensation (TempCo)
 - battery temperature monitoring (°C)
 - battery over-temp monitoring (for alarm)
- replaces the need for *both* ATevo TempCo (p/n EJ5304-0#) and ATevo battery shunt (p/n EJ5307-##)

3 SYSTEM REQUIREMENTS

- Connected rectifier must be **ATEvo** Series microprocessor-controlled float battery charger.

NOTICE As of physical printing of revision (12/10/2024) of this manual ([JA5136-00](#)), the HindleHealth+ accessory will *not* operate with legacy AT10.1 and AT30 Series float battery chargers.
- ATevo battery charger must have "A18" HindleHealth+ serial communications adapter (p/n EN5063-00) installed on Main Control Board (A1).
- One (1) HH+ unit is installed per battery, even with dual ATevos connected in parallel.
- System dc **power cabling** to-and-from battery, ATevo, and HindleHealth+ is *not* supplied with this product. This is supplied by installer.
- Before installation, access and review the HH+ Battery Commissioning Worksheet ([D15038-00](#)), featured on following page.
- Compile required battery data, and store it in (or on) the worksheet.



Battery Worksheet



DI5038-00

(<http://www.atseries.net/PDFs/DI5038-00.pdf>)



HindleHealth+

Battery Commission Worksheet

HindleHealth+ requires information about the connected battery. Use this worksheet to record values, *before* going on-site to commission the HindleHealth+ system.

No.	PROMPT	DESCRIPTION	ENTRY
1	Chemistry	battery chemistry types are grouped into four (4) categories: VRLA - absorbent glass mat (AGM) or gel cell batteries PbCa - lead-calcium (PbCa) PbSb - lead-antimony (PbSb) or lead-selenium (PbSe) NiCd - nickel-cadmium (NiCd)	_____ chemistry
2	Volts Per Cell	manufacturer's rated Volts per cell [V] <i>(CCV - closed circuit voltage)</i>	_____ Volts
3	How Many Cells	number of cells in battery bank <i>(confirm with ATevo data nameplate)</i>	_____ cells
4	Rated Capacity	manufacturer's rated battery capacity [in Ampere-hours] <i>(from manufacturer's data sheet, or printed on cells)</i>	_____ Ah
5	Tested Capacity	result of battery capacity test [in Ampere-hours] <i>(enter 0 if a capacity test was not performed)</i>	_____ Ah
6	Time In Service	how long battery has been in service at time of commissioning [in months] <i>(enter 0 if new)</i>	_____ months
7	Life Expectancy	manufacturer's rated life expectancy [in years] <i>(from manufacturer's data sheet)</i>	_____ years

5 INSTALLATION

5.1 Setup (dc bus)

- Install ATevo Series battery charger per supplied O&SI.
- Inspect the battery, connections to dc bus, and ATevo battery charger dc output (+/-) terminals.
- Carefully review the HindleHealth+ Field Installation Instructions ([JD5082-00](#)).
- Review and plan how and where the HindleHealth+ assembly will operate with other dc components.
- The HH+ smart battery shunt will lie along the **NEG(-)** dc bus, between the battery and dc load(s).

5.2 Mechanical (to wall)

- Identify a convenient wall-mounting location for HindleHealth+, near the **NEG(-)** terminal of the battery.
- Review the HH+ Style-5111 enclosure per Outline Drawing ([JE5260-00](#)).
- Remove the clear acrylic front safety shield from the HH+ Style-5111 enclosure.
- Wall-mount the HH+ Style-5111 enclosure per Outline Drawing ([JE5260-00](#)).

5.3 Power Wiring (to battery)

- If possible, *temporarily* remove the battery from the dc bus, using an upstream dc disconnect switch.
- Refer to the Internal Component Layout Drawing ([JE5281-00](#)), and identify user power connections.
- Disconnect the **NEG(-)** terminal of the battery, connected to the dc bus.
- Reconnect this lead (from the dc bus) to the *left* 3/8-16 ZPS stud terminal of the HindleHealth+ battery shunt, marked **LOD(-)**.
- Supply similarly-sized dc cabling.

NOTICE Power dc cabling to and from this product is *not* supplied with HindleHealth+, nor or by the HH+ manufacturer. Cabling should be supplied by the battery installer. All user wiring to and from HH+ should conform to NEC, CEC, local, and site codes.

- Connect the recently removed **NEG(-)** terminal of the battery to the *right* 3/8-16 ZPS stud terminal of the HindleHealth+ battery shunt, marked **BAT(-)**.

5.4 Vdc+ Sense Wiring (to battery)

- Refer to the HH+ Field Installation Instructions ([JD5082-00](#)).
- Open the HindleHealth+ bagged wiring package (p/n EJ5304-71).
- Identify the #18 AWG sense wire, marked **W.BAT+**.
- Connect the stripped end to **TB2** of the HindleHealth+ pc board, in the upper-right corner.
- Route the other end of the sense wire to the **POS(+)** terminal of the battery.
- From the bagged kit, chose one (1) of the supplied ring lugs appropriate for site battery terminals.
- Crimp selected lug to open end of sense wire **W.BAT+**.
- Connect sense wire to the **POS(+)** terminal of the battery.

5.5 Temperature Wiring (to battery)

- From the bagged wiring package, identify the shielded cable (twisted pair) marked **W.TEMP**.
- **NOTICE** The length of the battery cable is limited to 25ft / 7.6m, since HH+ should be mounted as close to the battery as possible.
- Connect the stripped ends to **TB3** of the HH+ pcb, in the upper-left corner. Polarity is not important.
- Connect ring lug (of the shielded ground) to the upper-left enclosure ground 1/4-20 stud terminal.
- Route the other end of the wire to the battery.
- From the bagged wiring package, select the "**A10**" temperature probe (p/n EJ5032-01).
- Connect the A10 probe, using slip-on lugs, to the other (*terminals*) end of the cable marked **W.TEMP**.
- Attached the probe (using the ring lug) to either:
 - the negative(-) terminal of one (1) of the battery cells
 - a battery inter-cell connector

INSTALLATION

5.6 HH+ Signal Wiring (to ATevo)

- From the bagged wiring package (p/n EJ5304-71), identify the shielded harness marked **W.A18**.
- NOTICE** The supplied HH+/ATEvo signal cable is 50ft / 15.2m. If a longer length of signal cable is required, please contact the Factory.
- From left-to-right, connect the harness to signal terminal block **TB1**, at the bottom of HH+ pc board.

Color	TB1	Terminal
red	PWR	V+
black	PWR	V-
white	RXTX	B+
green	RXTX	A-
drain	RXTX	COM

- Route the other end of **W.A18** harness to ATevo battery charger.
- Confirm both power (+/-) **and** signal connections to HindleHealth+. See image above.
- Replace safety shield on HindleHealth+ Battery Shunt.

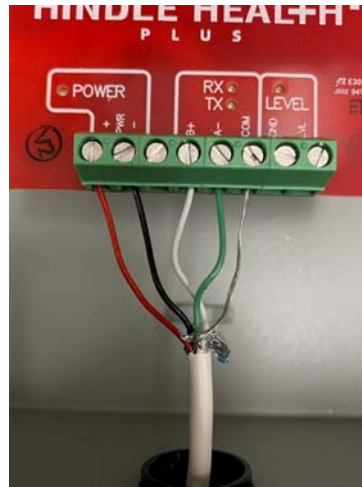

5.7 ATevo Signal Wiring (to HH+)

- Turn off (open) both ATevo front panel ac (CB1) and dc (CB2) circuit breakers.
- Open ATevo front panel door.
- Identify Main Control Board (A1) installed onto inside surface of door.
- If HindleHealth+ Interface Board (A18) is already installed from the factory, skip next three (3) steps.
 - If not, locate an **open** Serial Communications Port (Port 2 or Port 3) on left side of board.
 - Insert HindleHealth+ Interface Board (A18) into open port.
 - Press board down onto plastic standoffs to lock in place.
- Route harness marked **W.A18**, connected to HH+, through conduit entrance of ATevo.
- End harness at HH+ Interface Board (A18).
- From top-to-bottom, connect harness to signal terminal block **TB1**, at the left side of A18 pcb.

Color	TB1	Terminal
red	PWR	V+
black	PWR	V-
white	RXTX	B+
green	RXTX	A-
drain	RXTX	COM

- Confirm signal connections (see [JD5082-00](#)) to A18 pcb, then close ATevo front panel door.

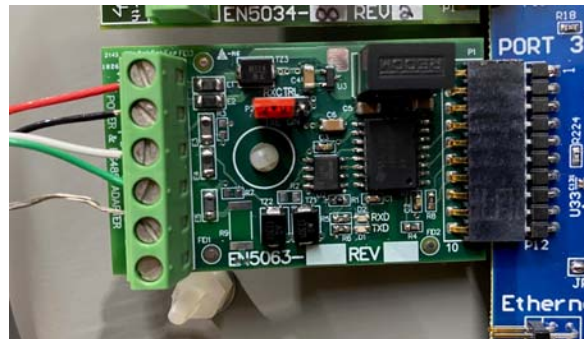

5.8 ATevo Battery Charger Re-energize

- If required, **reconnect** the battery to the dc bus, using upstream dc disconnect switch.
- Restart ATevo, by closing ac input (CB1) circuit breaker **first**.
- Close ATevo dc output (CB2) circuit breaker **second**.
- Confirm ATevo battery charger is operating normally, with new HH+ installation & signal wiring.
- ATEvo supplies power to HindleHealth+ battery shunt via connections in Sections 5.6 & 5.7.
- NOTICE** ATevo firmware does **not** automatically recognize HH+ battery shunt connection.
- Move on to Section 6.0 to configure the ATevo communications port (for HindleHealth+), via battery charger front panel controls & display.

6 COMMISSIONING HindleHealth+ / BATTERY

6.1 CONFIGURATION

Once all connections to HindleHealth+ are made, an ATevo communications port must be configured so HindleHealth+ can be detected by the battery charger firmware. Information about the batteries must also be provided, and enter via ATevo User Interface (UI).

- Open the ATevo front panel door.
- Locate the large Main Control Board (A1) mounted to the back surface of the door.
- Identify the port number (PORT 1, PORT 2 or PORT 3), labeled directly *above* the pin connector, that the HindleHealth+ Interface Board (A18) is plugged into.



- Select the **COMMUNI-CATION** icon from the ATevo main menu.

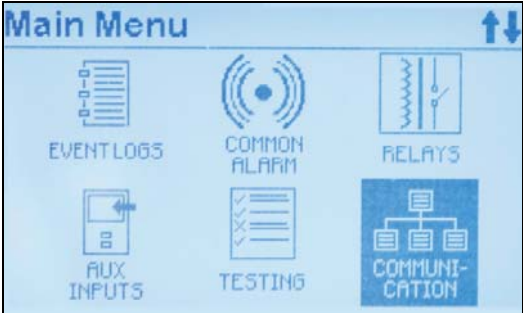

- Select the port number where the HindleHealth+ adapter (A18) is connected.
- Set it to **(Modbus mstr)**.
- Then press **Esc** to enter.

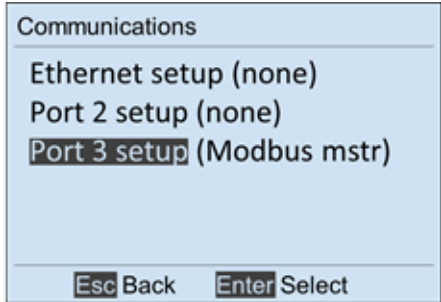

- Select **yes** when prompted to Reset Charger.

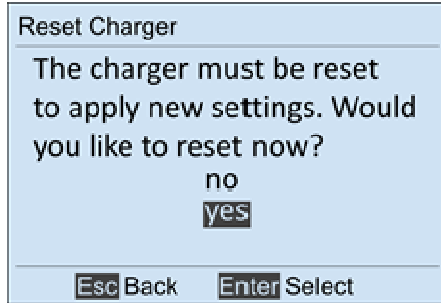

NOTICE Once ATevo is configured for HindleHealth+ (per the steps above), certain ATevo features are deemed redundant. The following three (3) native ATevo features are *disabled* (and not available), overridden by comparable HindleHealth+ functionality.

- EJ5304-0# - ATevo Temperature Compensation, from probe connected to ATevo (A2/A9)
- EJ5307-0# - ATevo Battery Shunt (R30), see [JA5124-07](#)
- n/a - ATevo native Open Battery Alarm, see ATevo O&SI Section 7.7

COMMISSIONING

6.2 HindleHealth+ COMMISSIONING

6.2.1 Battery Data

Review the data on the HH+ Battery Commissioning Worksheet (form p/n [DI5038-00](#)) from previous Section 4.0. The HindleHealth+ system requires the following information about your batteries:

- battery chemistry
- Volts/cell
- number of cells
- rated capacity
- tested capacity
- days since test
- battery age
- life expectancy

Item	Description
Battery Chemistry	battery chemistry types are grouped into four (4) categories: VRLA - absorbent glass mat (AGM) & gel cell batteries PbCa - lead-calcium (PbCa) PbSb/PbSe - lead-antimony (PbSb) or lead-selenium (PbSe) NiCd - Nickel-Cadmium (NiCd)
Volts Per Cell	manufacturer's rated (closed circuit) Volts per cell, in Volts (V)
How Many Cells	number of cells in your battery bank
Rated Capacity	manufacturer's rated battery capacity in Ampere-hours (Ah) from manufacturer's data sheet or printed on the cells.
Tested Capacity	result of recent battery capacity test in Ampere-hours (Ah) enter 0 if a capacity test was not performed
Time in Service	how long battery has been in service (in months) at time of commissioning - enter 0 if new
Life Expectancy	manufacturer's rated life expectancy (in years) from manufacturer's data sheet.

6.2.2 Entering Battery Data

Press the HindleHealth (HH) button on the ATevo front control panel.

The HindleHealth menu is displayed.

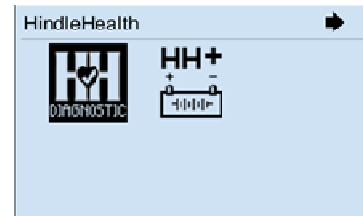

NOTICE If the standard HindleHealth "dialog" appears instead of the *menu*, the HindleHealth+ sensor has *not* been detected. It could take up to a minute to detect after configuring communications and rebooting.

The first icon leads to the standard HindleHealth diagnostic dialog. Select the **HH+** (above battery symbol) icon to commission your HindleHealth+ system.

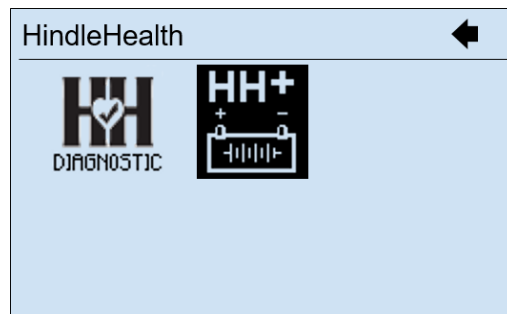

When the HH+ menu is selected, but the HH+ has not been commissioned yet, the following screen will appear.

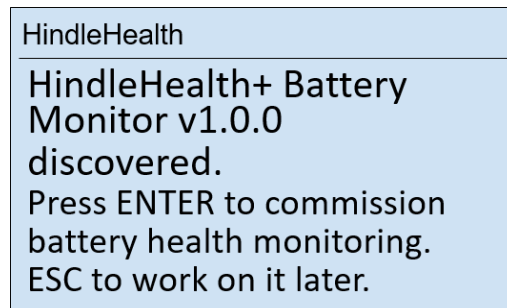

6.2.2 Entering Battery Data (continued)

The commissioning screens will guide you through entering the information about your batteries.

Enter the information from your HH+ battery commissioning Worksheet in the following sequence of screens to start monitoring the battery: Press ESC at any time to work on it later. Press back arrow to review or change a previous entry.

You may exit at any point, and resume later. Responses are stored as you advance to the next screen.

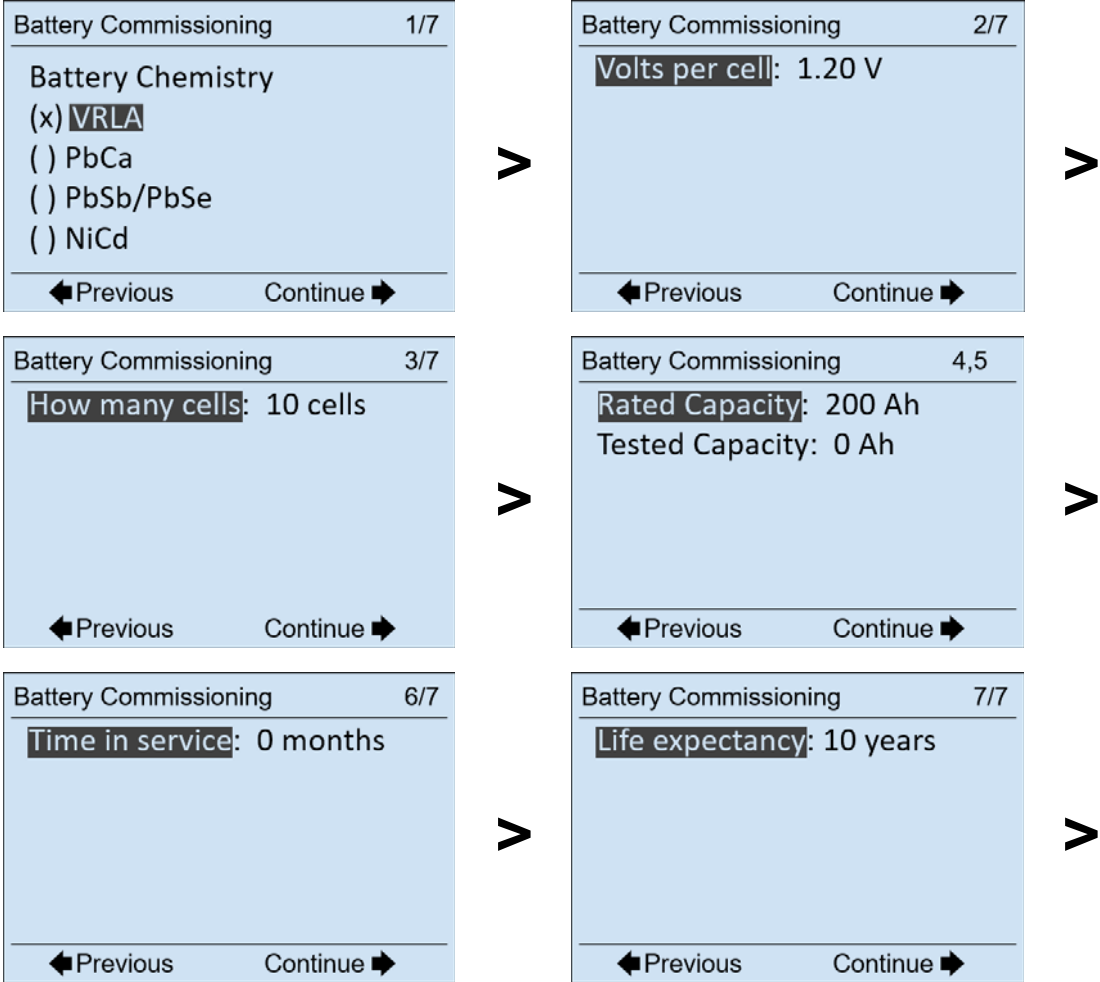

Review the summary carefully. If mistakes are entered, or data changes, see Section 6.2.4.

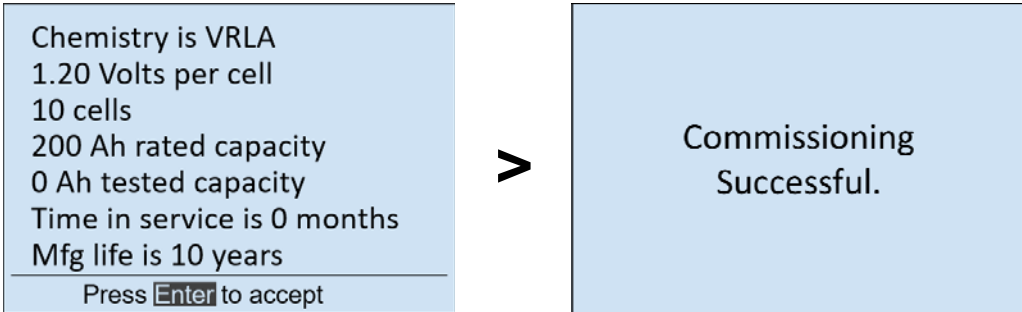

COMMISSIONING

6.2.2 Entering Battery Data (continued)

After commissioning, the ATevo display returns to the main **HindleHealth** menu.

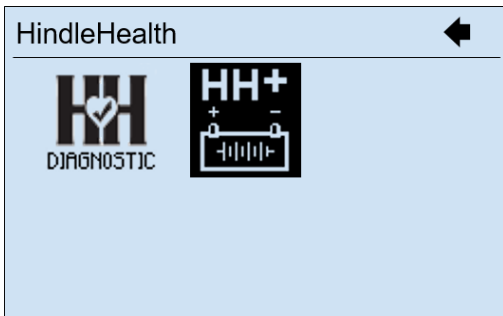

When the HH+ menu icon is selected, and the HindleHealth+ has been successfully commissioned, the following menu screen appears:

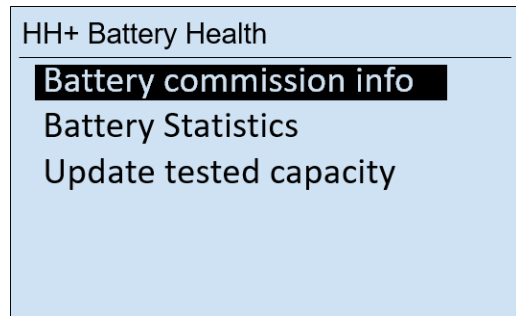

6.2.3 Monitoring Battery

Once HindleHealth+ commissioning is successful, there is no need to restart ATevo or HH+. The ATevo firmware immediately begins to monitor the battery via HH+. Additional ATevo features, activated by HH+, are detailed in Section 7.0.

The HH+ **Battery status** screen is easily and quickly available from the ATevo HOME screen, for a quick overview. Use the right (▶) or left (◀) arrow buttons to scroll through available screens, until battery status is displayed. See image to right for an example.

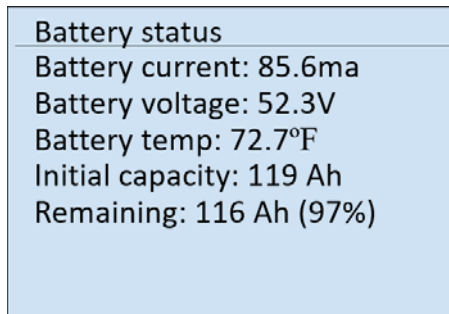

6.2.4 Modifying Data After Commissioning (contact factory)

After successfully commissioning HindleHealth+, the system will operate continuously and provide status information, without requiring any further user input or updates. If it is discovered that an error was made when entering the commissioning data, the incorrect item or items *can* be modified. It should be emphasized that "**Time in Service**" is how long the battery had been in service at the time of the original HH+ commissioning, and should *not* be updated. To modify commissioning data:

- contact [HindlePower, Inc.](#) (HH+ manufacturer) at **610.330.9000**
- ask to be put in contact with Technical Support (for HH+)
- a HindlePower technician will *personally* walk the user through steps of modifying battery data
- HindleHealth+ technical support is available Mon-Fri 8:00 AM to 5:00 PM (Eastern Time)

It is not necessary to reset ATevo, nor HindleHealth+, after changes are made.

6.2.5 Entering Updated Capacity Test Results

The IEEE recommends performing regular capacity/discharge tests. When these tests are performed, the results can be entered into HH+ to reset the Ah remaining estimate to the actual/tested value, should there be any variance. See Section 6.2.4 Modifying Data After Commissioning, for instructions on entering capacity test results.

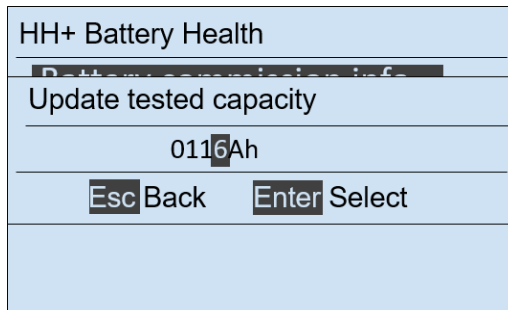

7 FEATURES

7.1 Battery Current Meter

Once activated, HH+ measures current (A_{dc}) through the smart shunt wired in series with the battery, along the neg(-) leg of the dc bus. The shunt can accurately measure +/- **2mA**, while handling continuous currents of up to **500 A_{dc}**. Larger battery shunts may be offered in different (*future*) HH+ models.

HindleHealth+ displays a pos(+) charge, or neg(-) discharge, **digital** value (A_{dc}) of battery current at the top-left of the ATevo **Battery Current Meter** screen. HH+ also displays a zero-center "bar" meter. The bar for **charging** current is displayed right of center, while the bar for **discharge** current is displayed left of center. HH+ will also calculate the amount (Ah) of charge or discharge totaled, for that event. This value is displayed to the right of the **type** of current ("Charging" or "Discharging"). Refer to images below for examples.

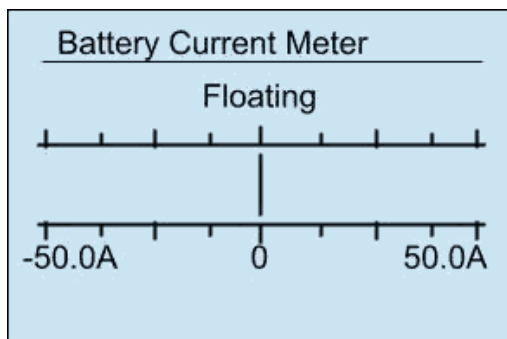
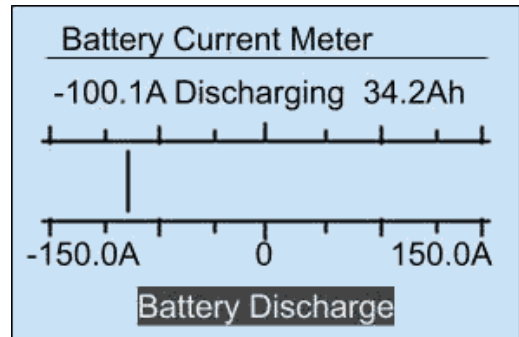
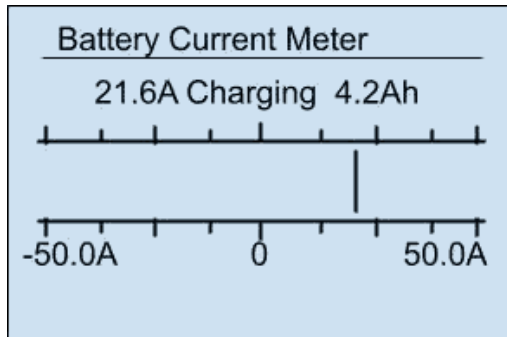

During a **Battery Discharge** event, the standard ATevo alarm indicator will appear at the bottom of the meter screen, as shown in image above.

During nominal operations, with ATevo in Float Mode, the Battery Current Meter will display "**Floating**", and the meter will be centered near zero. See image to left.

FEATURES

7.2 Battery Capacity (Ah) Remaining

A battery's capacity slowly degrades over its rated lifetime. How quickly the capacity fades depends on:

- a) operating temperature
- b) proper maintenance
- c) usage [depth of discharge & number of cycles]

HindleHealth+ monitors and logs these three (3) battery aging events. Using a propriety algorithm, it calculates "Battery Capacity Remaining", based on aging factor deductions compared to the rated battery life.

- To view battery capacity remaining, press the HindleHealth (HH) button on the ATevo front control panel.

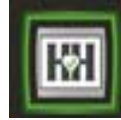

- The HindleHealth menu is displayed.
- On the **HindleHealth** display screen, choose the right **HH+** icon (with battery) selection.
- Press ENTER.

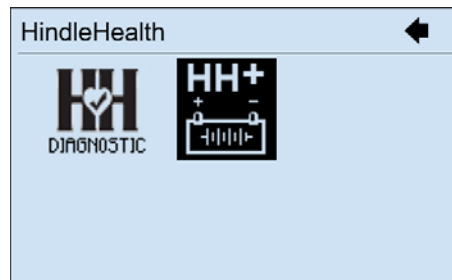

- When the HH+ menu item is selected, and the HH+ has been successfully commissioned, the **HH+ Battery Health** menu screen will appear.

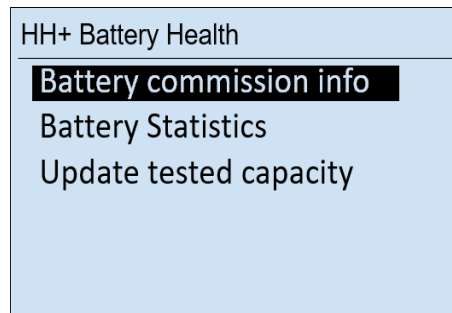

- To review previously-entered battery specifications, select (highlight) the top **Battery Commission Info** row.
- Press ENTER.
- The **Battery Commission Info** screen will appear for review only.
- Press ESC to return.

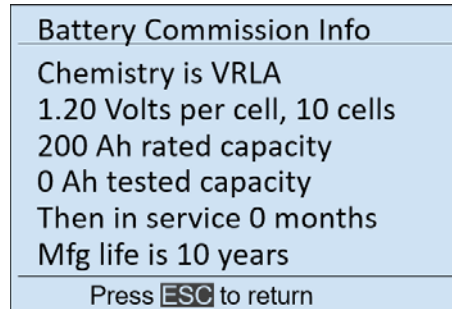

- To view calculated battery "health", select (highlight) the bottom **Battery Statistics** row.
- Press ENTER.
- The **Battery Statistics** screen will appear for review only.
- Press ESC to return.

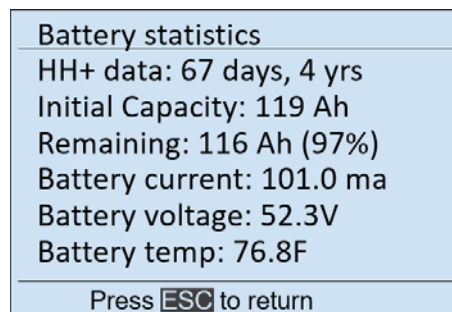

- Continue to ESC to return to previous screens, or back to the ATevo Home Screen.

7.3 HH+ Battery Voltage Sense

To monitor precise battery voltage present, HindleHealth+ requires a connection to the positive (+) terminal of the bank. See Section 5.4 for details. This measurement is only used for open battery monitoring, and capacity remaining calculations.

NOTICE HH+ battery voltage sense is *not* used for (and does not replace) the standard ATevo Remote Sense connection. If the battery charger is required to regulate output, based on voltage sensed at the battery, the standard ATevo Remote Sense terminals will *also* need to be connected to the battery. See ATevo battery charger O&SI Section 11 for standard Remote Sense connections, and ATevo firmware activation.

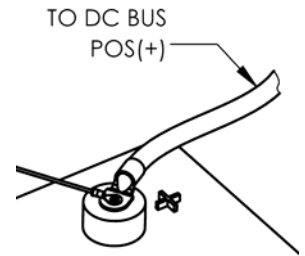

7.4 Battery Temperature Monitoring

Battery manufacturers specify recommended charger float and equalize voltages at 25 °C (77 °F) for their product. Temperatures above (or below) the *nominal* 25 °C require slightly lower (or higher) respective dc voltage levels, to prolong battery life and ensure reliable operation.

The ATevo Battery Temperature Compensation (TempCo) feature automatically *adjusts* the charger's dc output voltage, based upon battery temperature. In addition to the voltage compensation feature, the battery probe also allows ATevo to provide battery temperature *monitoring* (°C), and a battery over-temperature *alarm*.

NOTICE The HH+ battery temperature probe, installed in Section 5.5, eliminates the need for an ATevo TempCo option (p/n EJ5304-0#). Both should *not* be installed. With HH+ properly installed, ATevo will *ignore* temperature measurements from a standard TempCo "puck", wired directly the ATevo Power Board (A2). ATevo will instead utilize the temperature reading received from the HH+ serial communications, and measured by the supplied temperature probe (**A10**) in the bagged wiring kit.

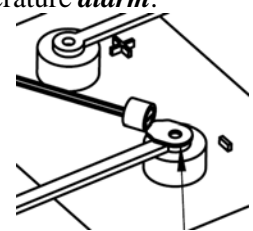

7.5 Battery Temperature Voltage Compensation

ATevo TempCo (and other battery temperature *features*) are supplied as standard with the HindleHealth+ accessory. Hardware consists of a bagged kit, including a Battery Temperature Probe (**A10**), and a signal cable marked **W.TEMP**, to connect the probe to the HH+ Smart Shunt PC Board. The A10 probe contains a temperature-dependent resistor, epoxy-sealed into to a standard ring lug. The probe is installed by bolting the lug on to (or near) the *negative* terminal, on one of the cells of the battery string. The battery temperature probe *must* be installed for proper HindleHealth+ operation. Refer to Section 5.5 for installation details.

This HH+ feature supplies (in ATevo controls) battery temperature:

- output voltage compensation
- monitoring (°C)
- alarm (adjustable °C)

For further details, including how to *activate* this feature in ATevo, after HH+ installation, refer to the TempCo User Instructions ([JA5015-51](#)).



7.6 Continuous Open Battery Monitoring (for alarm)

Once connected, HH+ will continuously monitor the status of the battery connection. The Open Battery Alarm will activate if the battery is *disconnected* from the dc bus. See Section 8.2 for alarm examples.

NOTICE Detecting an open battery is difficult in applications where multiple sources (other than the charger and battery) can supply power to the dc bus. HH+ will accurately detect an open battery, when all chargers (dc supplies) are HindlePower ATevo Series, and all batteries have the HH+ properly installed.

- HindleHealth+ includes a dc shunt connected *directly* to the battery. Therefore, when current is detected flowing through this shunt *into* the battery (charge), or *from* the battery (discharge), it is considered present and connected.
- If battery current (A_{dc}) is at zero, HindleHealth+ also monitors various parameters. It can detect when the battery is no longer connected to the dc bus, based on present and previous operating states of the dc system. To avoid false alarms, HH+ always confirms Open Battery conditions using at least two (2) different *proprietary* tests.

ALARMS

8 ALARMS

Once activated, HindleHealth+ allows ATevo firmware to monitor for seven (7) possible alarms.

8.1 Battery Discharge Alarm

Once activated, HindleHealth+ measures current (Adc) through a shunt, wired in series with the battery, along the negative (-) leg of the dc bus. See Section 7.1 for further details.

During normal operations, ATevo will supply current to the dc loads, as well as supply charging (floating) current to the battery. If the ac should fail, and the battery becomes a source of power to the loads, current will switch direction through the shunt. During such a battery discharge event, the standard ATevo alarm indicator "**Battery Discharge**" will appear at the bottom of the screen. Refer to image for example.

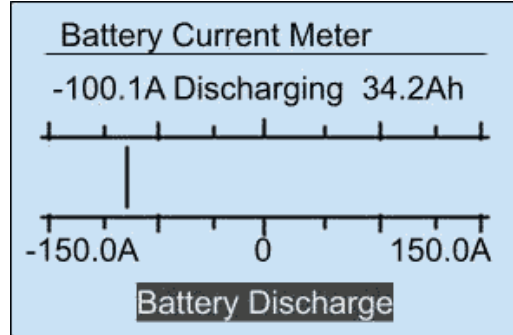

8.2 Open Battery Alarm (continuous)

This alarm activates if there is an internal battery open condition, or if a battery wire becomes disconnected. See examples below. The left example is from the **HOME SCREEN**, the right from the **Battery Current Meter** screen.

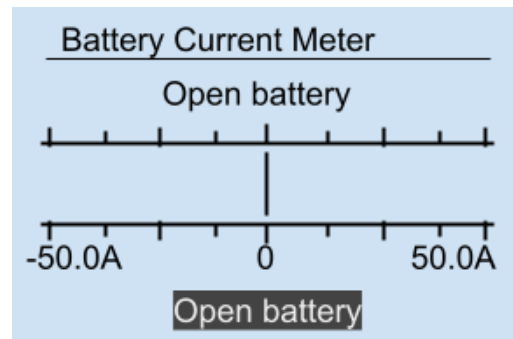
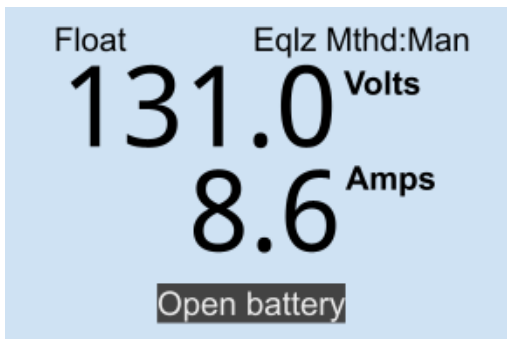

The process by which HindleHealth+ continuously monitors (and can detect an open battery condition) is proprietary information to the manufacturer, but is summarized in Section 7.6. This alarm is not latched. The HH+ Open Battery Alarm automatically clears when the battery is detected again.

NOTICE The HindleHealth+ *Continuous* Open Battery Alarm is different than (and often preferable to) the ATevo native Open Battery Alarm. This is particular feature covered in ATevo O&SI Section 7.7.

8.3 HH+ Sensor Failure Alarm

This alarm activates if the HindleHealth+ sensor loses power, or HH+ loses communication with ATevo. Once HindleHealth+ is detected by ATevo, it is expected to be present thereafter.

If this connection is lost, the alarm shown to the right will occur. To clear, confirm HH+ installation featured in Sections 5.3 through 5.7.

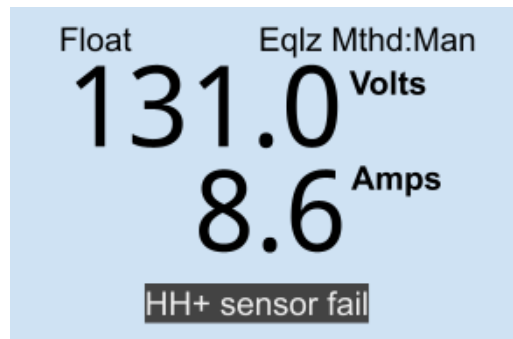

8.4 HH+ Vbat probe err Alarm

This alarm indicates that the HH+ Vbat+ probe is not connected to the positive(+) battery terminal. Confirm installation per Section 5.4.

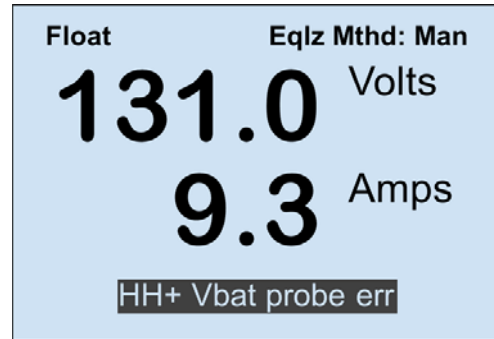

8.5 Battery Overtemp Alarm

The Battery Overtemp Alarm activates if the temperature measured at battery, rises to levels greater than the Battery Overtemp set point. By default, the Battery Overtemp set point is 54 °C (129 °F). The right image example indicates the temperature of the battery is greater than the user-defined set point.

This setting can be changed from the Battery Settings menu. See also ATevo TempCo User Instructions ([JA5015-51](#)).

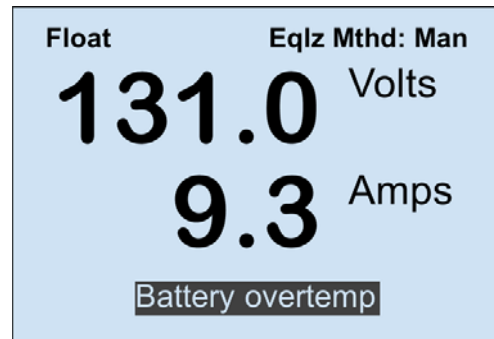

8.6 Battery Temp Probe Fail Alarm

This alarm indicates a loss of communication with the battery temperature probe (A10), specific for HH+. It does *not* relate to the legacy battery temp probe, which connects to the Power Board (A2) w/o HH+. The right example indicates when communication with the HH+ temperature probe (A10) is lost.

Confirm A10 TempCo probe installation and wiring to HH+ per Section 5.5.

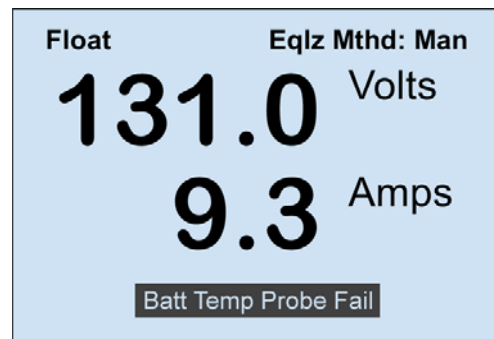

BATTERY EVENT LOGGING

9 BATTERY EVENT LOGGING

HindleHealth+ battery data is stored in flash memory on the ATevo Main Control Board (A1), the same as charger alarm event log data. Battery data persists in flash memory the same way the event logs are stored, if ATevo resets or power cycles. The battery data file is *not* human-readable.

- 9.1 Battery data can be exported *to* an SD memory card.
- 9.2 It may be necessary to replace the ATevo Main Control Board (A1). Battery data can be imported *from* an SD memory card.

For further details on HH+ battery data stored in ATevo, see battery charger O&SI Sections:

- Section 6.5 - SD Card Memory Features
- Section 9 - Event Logs

10 PARALLEL CHARGER OPERATION (with **HindleHealth+**)

HindleHealth+ is a smart battery *shunt*, meant to be connected along the negative (-) leg of one (1) industrial battery installation. It communicates with one (1) ATevo microprocessor-controlled charger, which performs all digital dc monitoring and event logging functions. In many industrial applications, *dual* (redundant) chargers are often connected in parallel, onto one (1) battery. This redundancy allows one (1) of the chargers to be powered down, without losing float voltage to the battery, and without losing power to the standing (constant) and transient (temporary) dc loads. In some parallel charger installations, the two (2) units are required to *share* the dc load, via signal communication and rectifier software control. Detailed instructions of the ATevo Forced Load Sharing *option* is described in User Instruction ([JA5054-50](#)).

With two (2) ATevo chargers, connected in Forced Load Sharing onto one (1) battery, only one (1) HindleHealth+ unit is required per installation. It is recommended by the manufacturer, though not required, that the HH+ smart battery shunt be connected (via signal cable detailed in Section 5.6) to the *primary* ATevo. The secondary ATevo, forced to share the dc load, has certain control functions superseded by those of the primary ATevo. Since monitoring of Forced Load Sharing will be controlled by the *primary* ATevo, it is logical to have the same primary ATevo perform dc monitoring and event logging for the HindleHealth+.

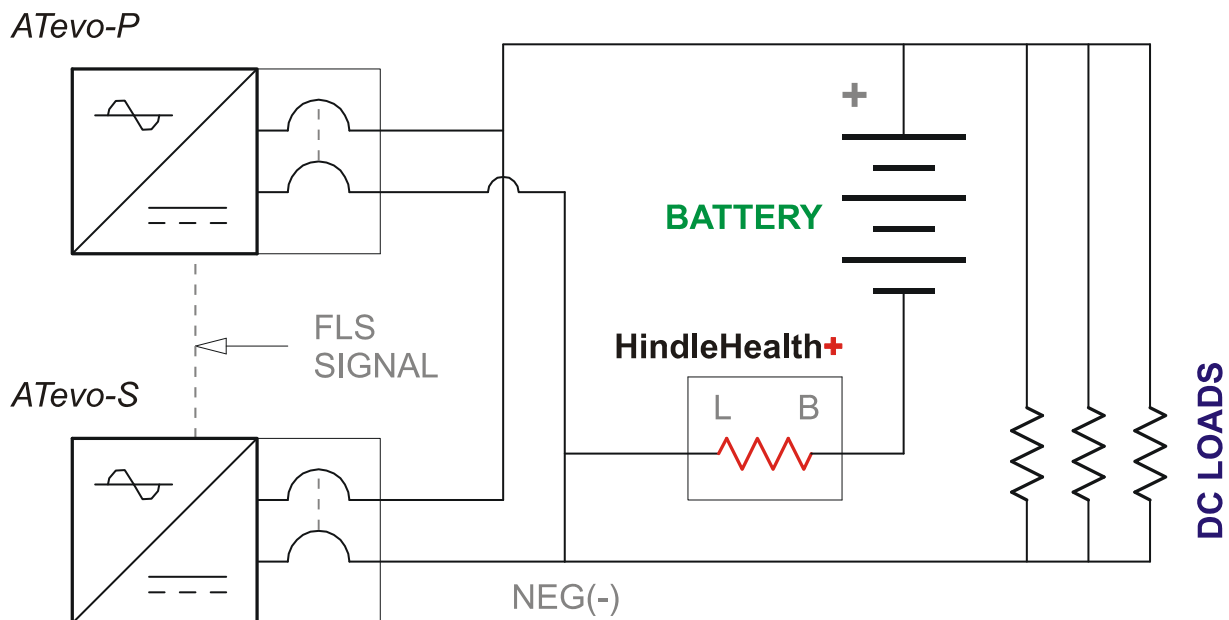

For related documentation, refer to the following:

- [JA5054-50](#) ATevo Forced Load Sharing User Instructions
- [JF5000-00](#) ATevo / HindleHealth+ Sample System Configurations

11 Modbus MASTER (generic)

Modbus master over serial is implemented in ATevo firmware v3.1.0 and later. Modbus master running over Ethernet is *not* supported. The Modbus master implemented in ATevo can only interact with Modbus devices that are supported by the version of firmware installed on the ATevo. Currently, the only Modbus device that is supported by an ATevo Modbus master is the HH+ battery sensor.

Modbus devices are wired to an EN5036 or EN5034 serial line driver board plugged into port 2 or 3 on the ATevo Main Control Board (A1). The EN5036 supports RS485 only, and can supply 5Vdc to a device that requires an external dc power supply. The EN5034 can be configured to support RS485 or RS232 but does not include a 5Vdc power source. Multiple devices can be wired to the same serial line driver board (EN5036 or EN5034 set to RS485) as long as all devices support RS485 and use the same serial configuration (stop bits, baud rate, etc.) on Modbus master. The 5Vdc power supplied on EN5036 has limits as to how many devices can be powered through it.

The steps below describe how to set up any Modbus device supported by ATevo.

1. For devices that require an external 5v power supply, wire power and RS485 connections from the device to an EN5036 adapter plugged into port 2 or 3 on the ATevo main control board (EN5031). HH+ battery sensor requires an EN5036 adapter.
2. For devices that have their own power supply, wire RS485 (or optionally RS232) connections from the device to an EN5034 adapter plugged into port 2 or 3 on the ATevo main control board (EN5031).
3. Follow the directions below to enable and configure a Modbus master through the user interface.

Enable and configure a Modbus master

Navigate to the ATevo communications menu. Select the port number that the serial adapter and device are connected to. Select “Modbus mstr” as the communications protocol. Modbus master supports configuration for baud rate, stop bits, parity, and handshake. HH+ battery sensor serial settings are fixed at 8, N, 1, 9600 baud which are the default settings for Modbus master. Do not change them for HH+ battery sensor.

Modbus Device Registry (generic)

A Modbus device registry is stored in ATevo set point configuration. The registry keeps track of Modbus devices ATevo supports and whether the ATevo ever discovered them.

Modbus Device Discovery (generic)

As of firmware version 3.1.0, the only Modbus device that ATevo supports is a single HH+ battery sensor. The ATevo may support other Modbus devices in the future. The following explanation is broad in that it describes Modbus device discovery if ATevo were to support devices other than HH+ right now.

Modbus device discovery is performed by ATevo Modbus master firmware for every serial comm port that is configured as Modbus master. Device discovery consists of polling the known Modbus address of every device ATevo supports for the purpose of determining if the device is present on a Modbus master. The data the device responded with is used to verify it is a device ATevo supports. A Modbus device that ATevo supports is recorded in the registry the first time it is discovered. ATevo will expect that device to be present from then on. An alarm notifies that a device is absent when the registry indicates it should be present. A separate alarm notifies that a device that was discovered and responding at startup but stopped responding sometime later. It is possible to tell ATevo to “forget” a device that was previously discovered if the device will no longer be used in an application. This will prevent any alarms that indicate the device is missing. ATevo will still attempt to discover the same device. If it remains connected to the charger through Modbus, it will be discovered again. The device must be disconnected, as well as forgotten, to permanently eliminate alarms and any other device support through the user interface.

Discovery polls for each supported Modbus address occur as often as 3 times a second continuously, for the first minute immediately after ATevo resets or is power cycled. Discovery polls slow to once every 10 seconds after the first minute, and continue indefinitely until all devices either expected or supported are discovered. Discovery polling ends entirely when all devices that the ATevo supports are discovered.

To be clear, ATevo will only attempt to discover devices it supports on specific Modbus addresses. The only device that firmware currently supports is a single HH+ battery sensor at Modbus address 222. As such, this is the only Modbus address that ATevo polls during discovery. Discovery ends when a HH+ battery sensor is discovered. ATevo only supports a single HH+ device on one of the Modbus masters. This being the case even if two ports were configured as Modbus master, and a HH+ battery sensor was connected to each of them. The first one discovered would begin to work. The other would never be polled.

PARTS DATA PACKAGE

Sold to: *(customer)*

Ship to: *(various)*

Model: **EJ5178-00**

Ser. No.: *(CUST.PO#/MFG.SALES#)*

Factory Configuration No.: EJ5178-00

EI5094-04	FNTM,KIT,FINAL.DOCS,HH+,EJ5178-00
EJ5178-01	STOK,HH+,500A,STYLE-5111
EJ5288-18	FNTM,HH+,ATEVO.ADAPTER,A18,BAGGED
EJ5304-71	ACSY,HH+,WRNG,TMP/+VDC:25'+WA18:50'

Reference Designator	Factory Part Number	Description	Quantity per Unit	Start-up Spares	Operating Spares	PM Spares
WTEMP	EH5058-71	FNTM,HRNS,HH+,TEMPCO,#18,25'	1			
A10	EJ5032-01	ASSY,PUCK,TEMPCO,AT,10K,W/LUG,3/8"	1			
A18	EN5063-00	ASSY,PC.BRD,EV#,COMM.ADPTR,HH+,A18	1			
BAT(-)	EI5397-01	ASSY,I/O.STUD,GLASTIC.STANDOFF,HH+	1			
FLDINS	JD5082-00	INSTR,FLD,HH+,WIRING,A18/TEMP/BAT+	1			
LOD(-)	EI5397-01	ASSY,I/O.STUD,GLASTIC.STANDOFF,HH+	1			
USERIN	JA5136-00	MANUAL,O&SI,ATEVO,HH+,EJ5178	1			
A1	EN5066-00	ASSY,PC.BRD,SHUNT-MTG,HH+,500A	1			
LUG-1	RC0023-33	TERM,RING,INS,NYLON,#22-18AWG,1/4"	1			
LUG-2	RC0023-35	TERM,RING,INS,NYLON,#22-16AWG,5/16"	1			
LUG-3	RC0023-34	TERM,RING,INS,NYLON,#22-18AWG,3/8"	1			
LUG-4	RC0024-06	TERM,RING,UNINS,#22-16AWG,1/2"-HOLE	1			
R1	RB5019-00	RES,SHUNT,0.25%.ACCY,50MV,500A,G	1			
WA18	RH5005-00	WIRE,SHLD,TWST.PR,2X2,R/B+W/G,#22GA	50.25			
WBAT+	RH5001-18	WIRE,XLP,600V,125°C,BLACK,#18AWG	25.25			

A priced spare parts list is available. Please contact your sales representative.

Prior to ordering parts, verify installed components in the unit, as substitutions are occasionally made.

All data featured in this customized report supercedes any standard parts listed in the O&SI users' manual.

ORDER ENTRY SPECIFICATIONS:

- Industrial Battery Sensor for ATevo charger
wall-mount enclosure w/clear acrylic front panel
[dims: 14.00in W x 9.90in H x 4.10in D]
PROVIDES (via ATevo charger)
- continuous open battery monitoring (w/alarm)
 - calculated battery Ah capacity remaining
 - battery charge/discharge metering (+/-Adc)
 - battery discharge alarm
 - battery temperature via wired remote probe w/ring lug
 - battery temp voltage compensation (TempCo)
 - battery temperature monitoring (°C)
 - battery over-temp monitoring (for alarm)

LINE ITEMS: for Harness

- EJ5288-18 bagged kit for ATevo adapter board (A18)
- EJ5304-71 HH+ bagged wiring kit
 - 25ft battery temp probe & 25ft +Vdc sense probe
 - 50ft cable to ATevo (for power/communications)

NAMEPLATE DATA

IDENTITY: *(branding)*
TYPE: Battery Sensor
MODEL No.: EJ5178-00
SERIAL No.: *(CUST.PO#/MFG.SALES#)*
PRODUCT: HindleHealth+
RATING
DC VOLTS: 300
DC AMPERES: 500 (continuous)

HindleHealth+

Exclusively available with ATevo



Reliably Provides:

- **Continuous Open Battery Monitoring**
- **Ah Capacity Remaining**
- **Battery Discharge Alarm**

HindlePower's pursuit of DC System Reliability has led to the development of the HindleHealth+. An electronically enhanced shunt, capable of continuously detecting open battery and calculating the anticipated amp-hour remaining in your battery offering the industry's highest level of resolution and accuracy.

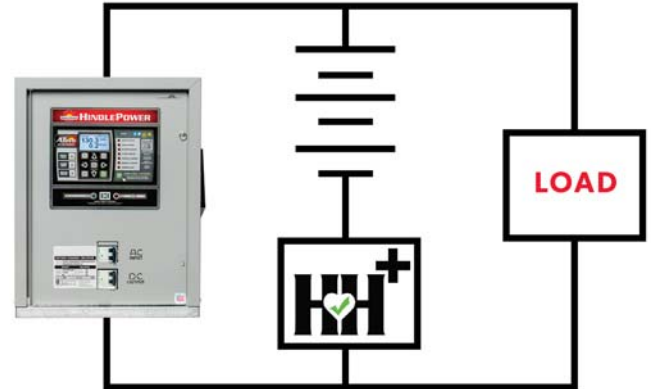

Battery Capacity
Initial capacity: 250.0 A/h
Remaining: 232.4 A/h
Percent remaining: 93%
Weeks commissioned: 62

(Sample Screen)

- **Utility compliance with NERC PRC-005 & TPL-001**
- **Useful with both Lead Acid and NiCad Batteries**
- **Clear protective shield for easy inspection of battery connections**
- **Easily mounts to battery rack or wall**
- **Temperature Compensation included**

SPECIFICATION

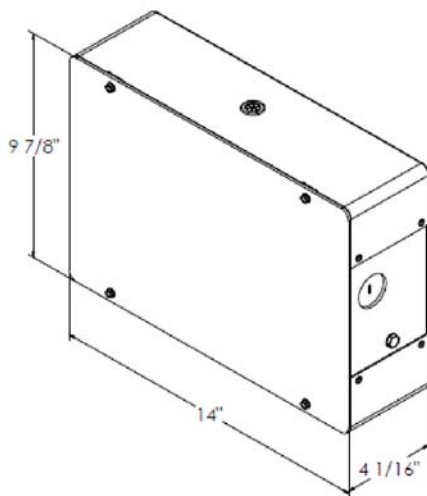

Ordering Information	
Part Number	EJ5178-00
Contact factory for ordering details	

BATTERY CURRENT

Shunt Rating (Continuous):	500A/50mV
Resolution:	
0-1AMP	0.1mA
> 1AMP, or (-) Amps	100mA
Accuracy:	
0-1AMP	+/- 1mA
> 1AMP, or (-) Amps	+/- 0.1% of FS

FLOAT CURRENT

Range:	0-1A
Resolution:	0.1mA
Accuracy:	+/- 1mA

BATTERY VOLTAGE

Input Resistance:	3.2MΩ
Range:	0-300V
Resolution:	100mV
Accuracy:	+/- 0.25% of FS

Specifications subject to change

RELATED DOCUMENTATION

14 RELATED DOCUMENTATION

The following documents are referred to in the previous passages. Please have access to the following:

- [JA5136-00](#) **latest revision** of HindleHealth+ User instructions (*this sheet*)
- [JF5081-00](#) Manufacturer's HindleHealth+ Technical Cut Sheet
- [DI5038-00](#) HindleHealth+ Battery Commissioning Worksheet
- [O&S/](#) ATevo Series Battery Charger **Operating & Service Instructions:**
[JA0102-51](#) (1PH G1), or [JA0102-52](#) (1PH G2), or [JA0102-53](#) (3PH)
- [JA5015-51](#) Battery Temperature Compensation (TempCo) for ATevo Battery Charger

The following drawings are referred to in the previous passages. Please have access to the following:

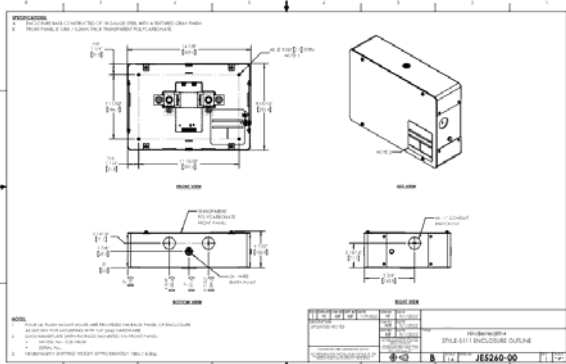

HindleHealth+ Style-5111 Enclosure Outline Drawing
[JE5260-00](#)

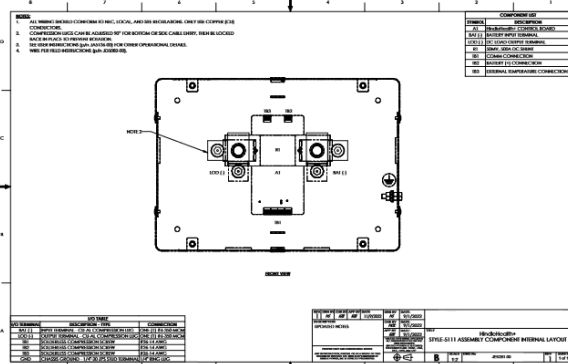

HindleHealth+ Style-5111 Internal Component Layout Drawing
[JE5281-00](#)

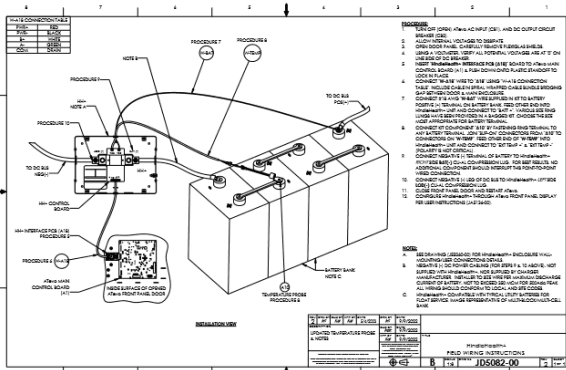

HH+ Field Installation Instructions / Connection Diagram
[JD5082-00](#)

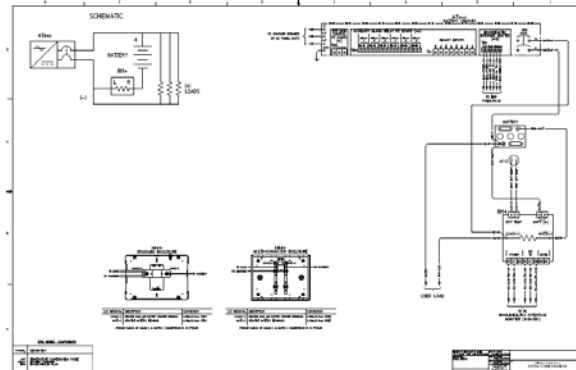

HH+ Sample System Configurations
[JF5000-00](#)

DOCUMENT CONTROL INFORMATION

Document Number: **JA5136-00**
Revision Level: **S**
Electronic Filename: **[JA5136-00.RevS.HH+OI.doc]**
Last Date Saved: **[12/10/2024 10:31 AM]**
Last Date Printed: **[12/10/2024 10:31 AM]**



ON-LINE AVAILABILITY

An electronic copy of these instructions is available at <http://www.ATSeries.net/PDFs/JA5136-00.pdf>, along with standard drawings for the ATevo Series battery chargers. Saved online in Adobe Acrobat Portable Document Format (PDF), they are readily available for downloading and printing.



HindlePower, Inc.

Address: 1075 Saint John Street
Easton, PA 18042-6661

Phone: **610.330.9000**

Fax: 610.330.8510

Online: www.hindlepowerinc.com